



OPEL

Insignia Sedan F69 11/2008-
Insignia Hatchback F68 11/2008-
Insignia Sports Tourer F35 11/2008-

CHEVROLET

Aveo HB MY 2012-
Aveo SDN MY 2012-
Cruze HB MY 2012-
Cruze NB MY 2010-

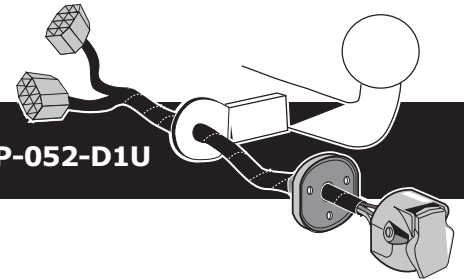

Partnr.: OP-052-D1U

- Fitting instructions electric wiring kit tow bar with 13-P socket up to DIN/ISO Norm 11446.
- We would expressly point out that assembly not carried out properly by a competent installer will result in cancellation of any right to damage compensation, in particular those arising by virtue of the product liability act.
- Contents of these kits and their fitting manuals are subject to alteration without notice, please ensure that these instructions are read and fully understood before commencing installation.
- Do not overload circuits; the maximum loads per connection are detailed in this manual.
- Attention! Before Installation, please read this manual carefully and inform your customer to consult the vehicle owners manual to check for any vehicle modifications required before towing.
- In the event of functional problems, troubleshooting must be limited to about 0.5 hours, contact the technical support:
t.skinner@ecs-electronics.com / 07440 202 052.



Part list

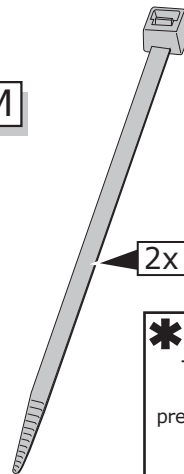
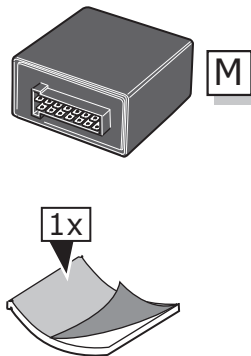
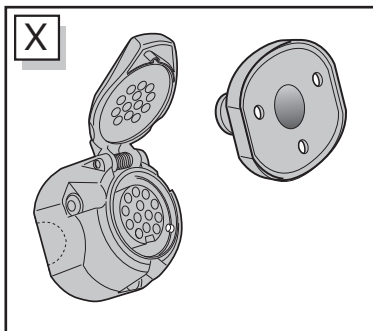
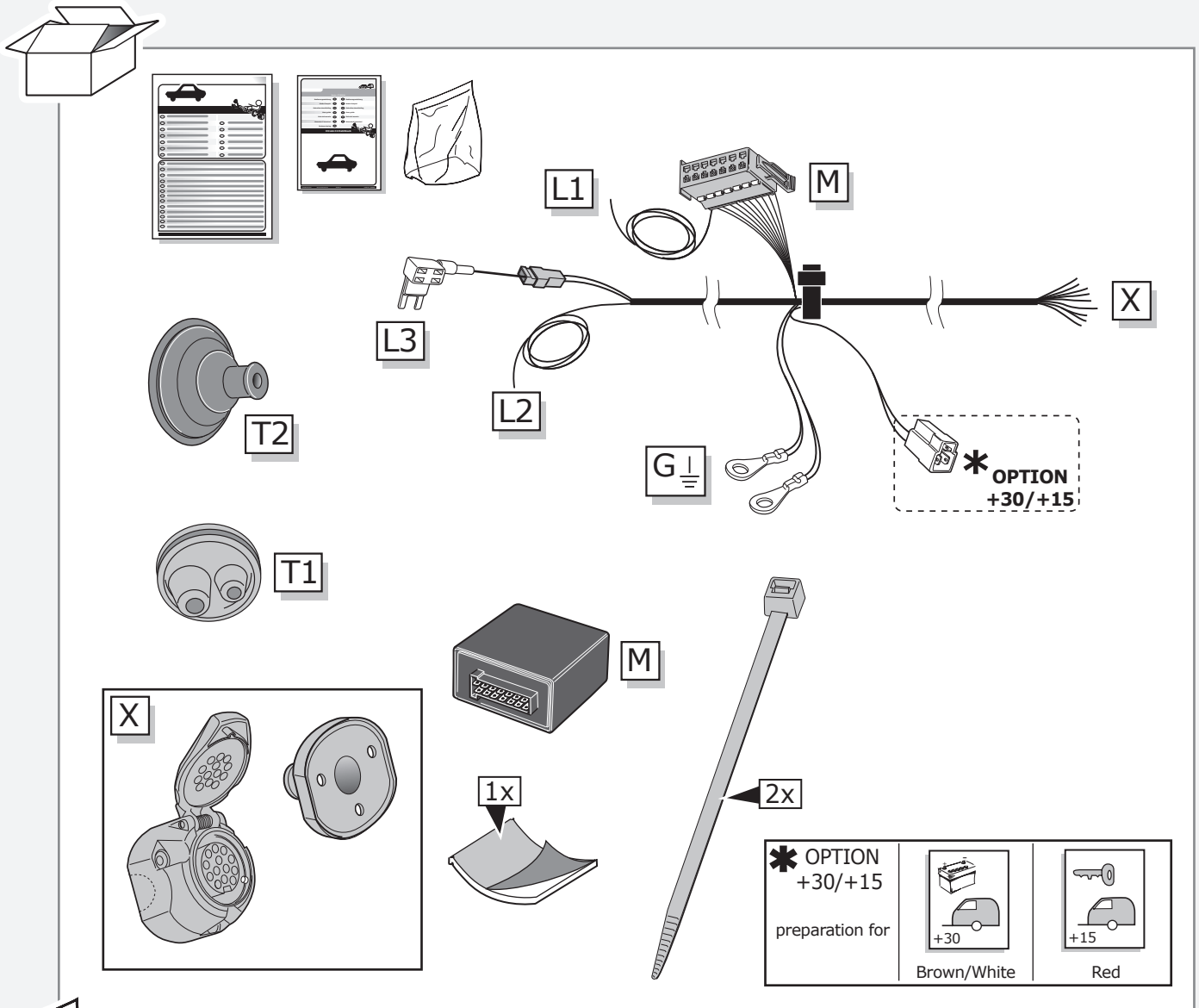

* OPTION +30/+15 preparation for

Brown/White	Red

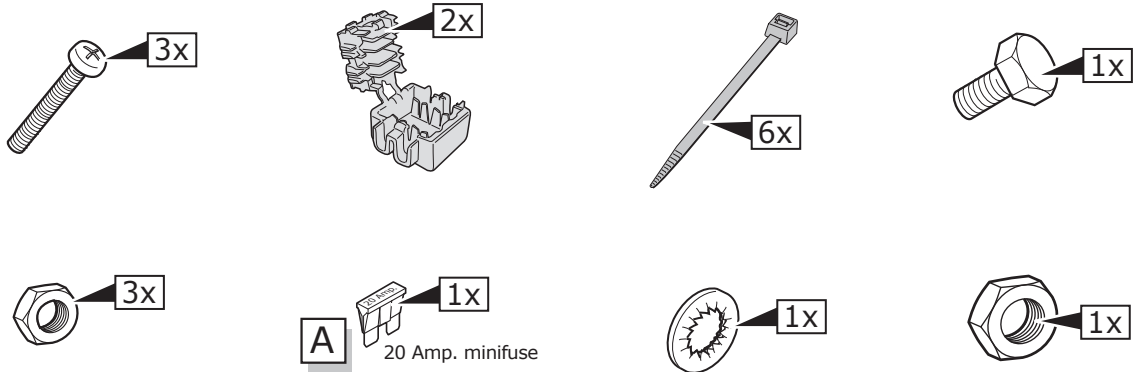

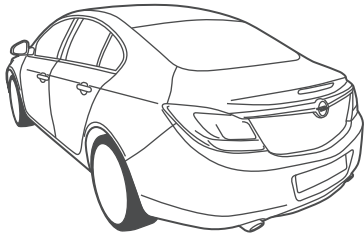

Insignia SD

Pag. 4
-
Pag. 8

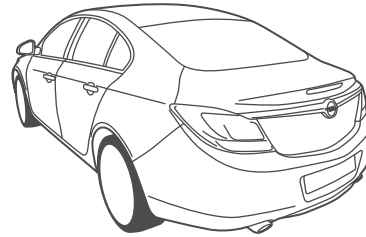

Insignia HB

Pag. 9
-
Pag. 12

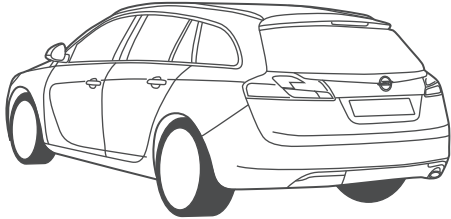

Insignia ST

Pag. 13
-
Pag. 17

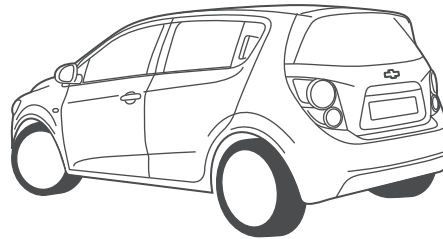

Aveo HB

Pag. 18
-
Pag. 20

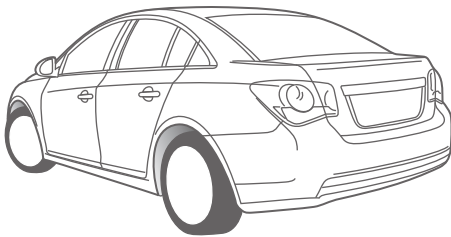

Aveo SD

Pag. 21
-
Pag. 23

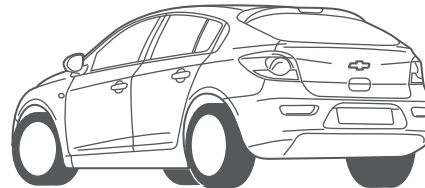

Cruze HB

Pag. 24
-
Pag. 26

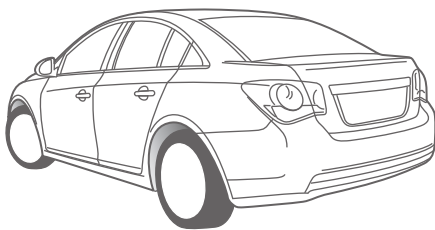

Cruze NB

Pag. 27
-
Pag. 30

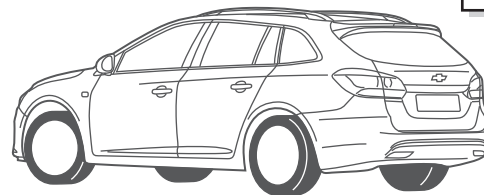

Cruze SW

Pag. 31
-
Pag. 33

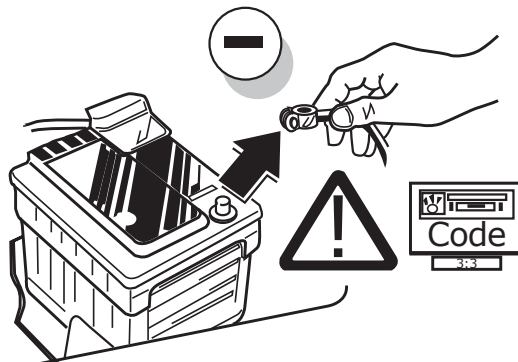

INFO

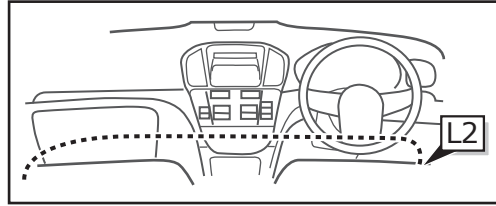

Insignia SD

Pag. 4

-

Pag. 8

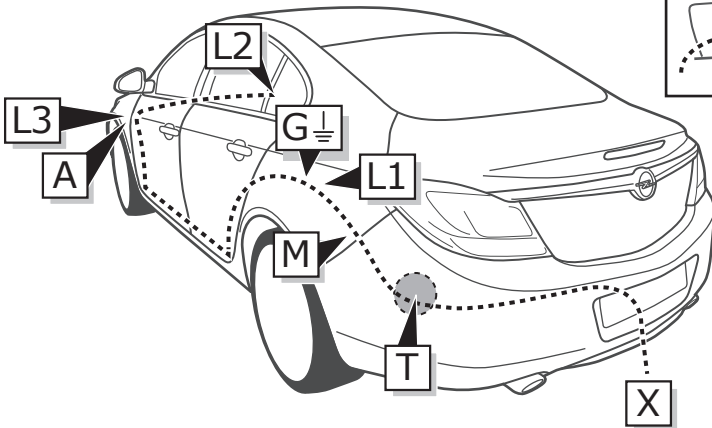

1

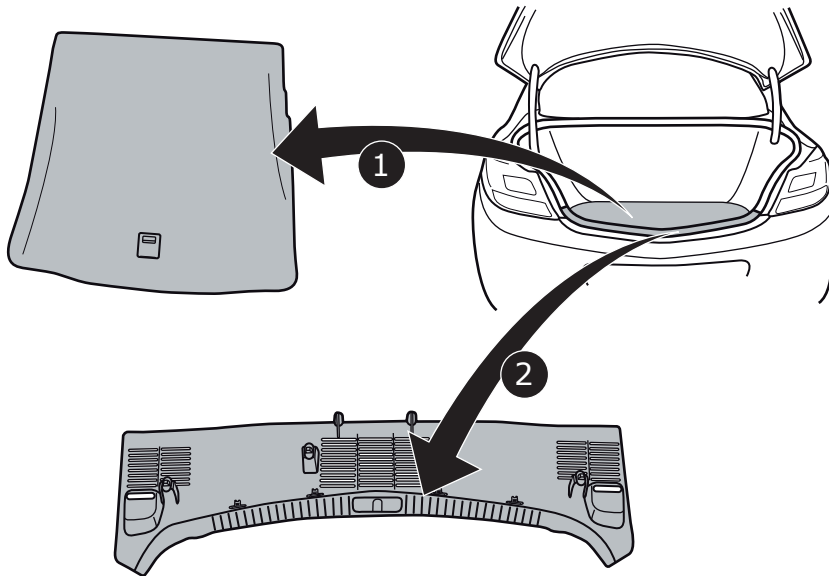

2

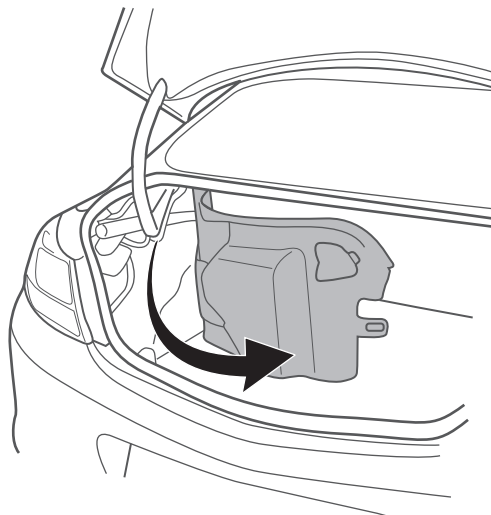

3

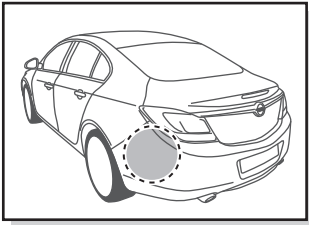
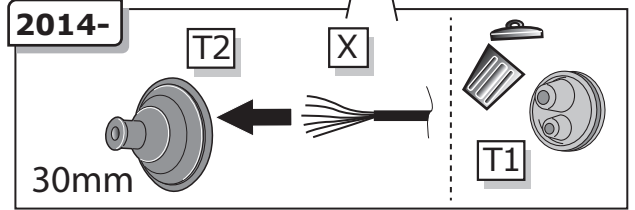
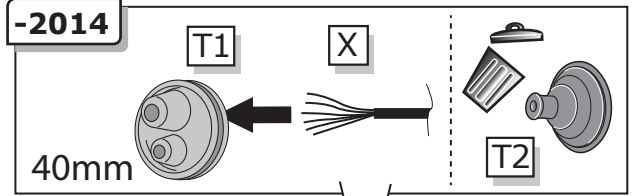
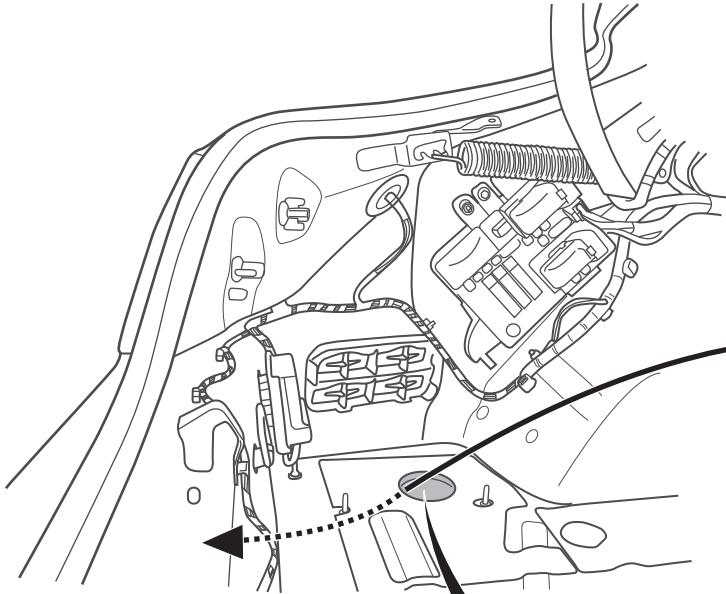

4



5

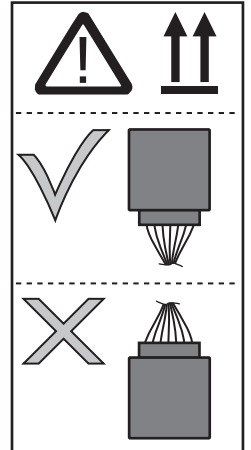
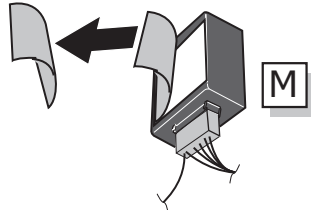
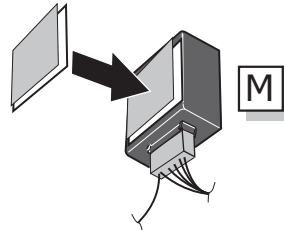
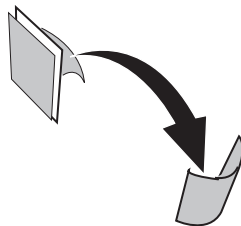
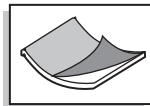
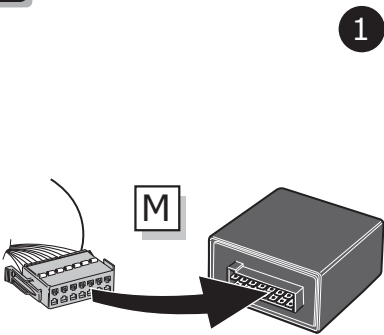

6

M

1

2

3

10 mm

G

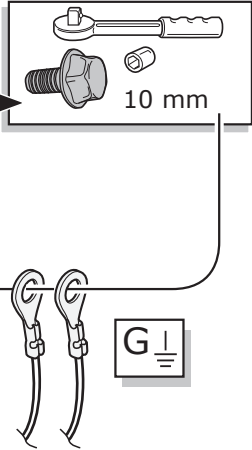
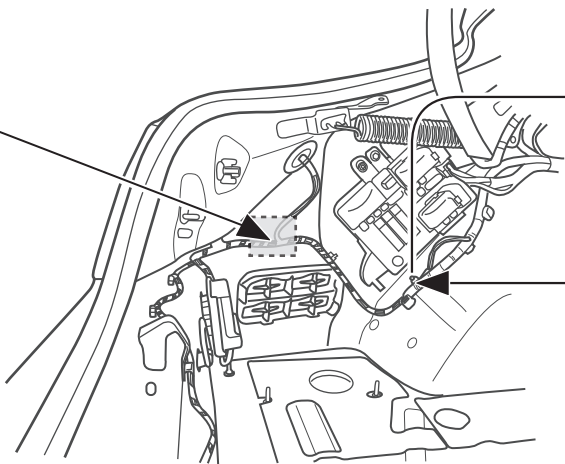
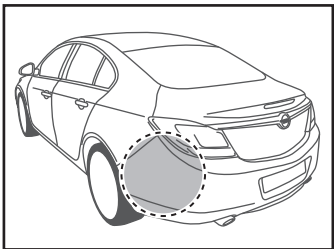

7

-2014

L1



54 STOP

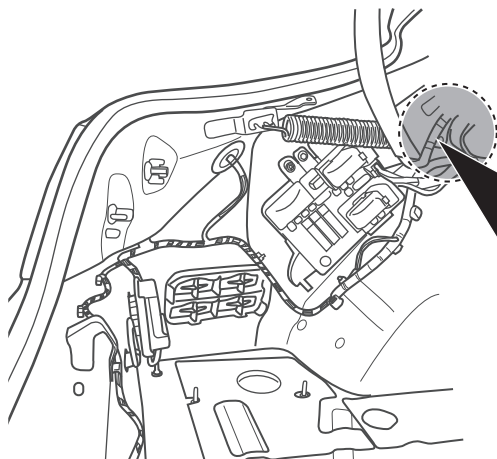
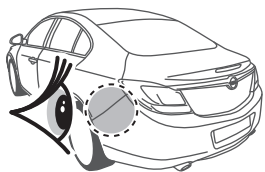

White



1

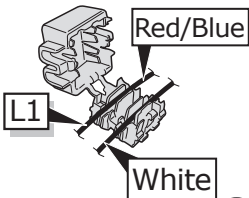

White

2

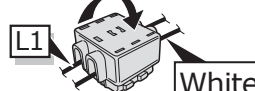

White

3

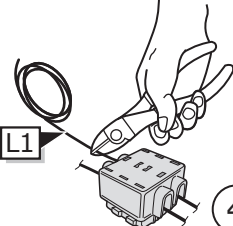

4

8

2014-

L1



54 STOP

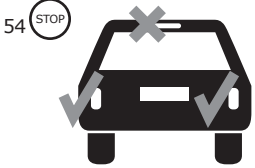
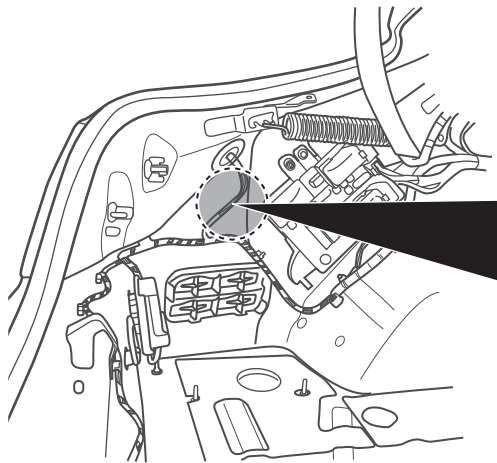
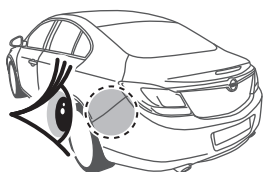

Grey/Yellow



1

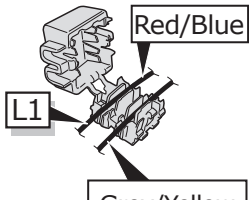

Grey/Yellow

2

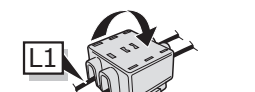

Grey/Yellow

3

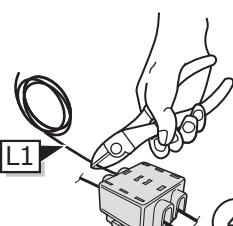

4

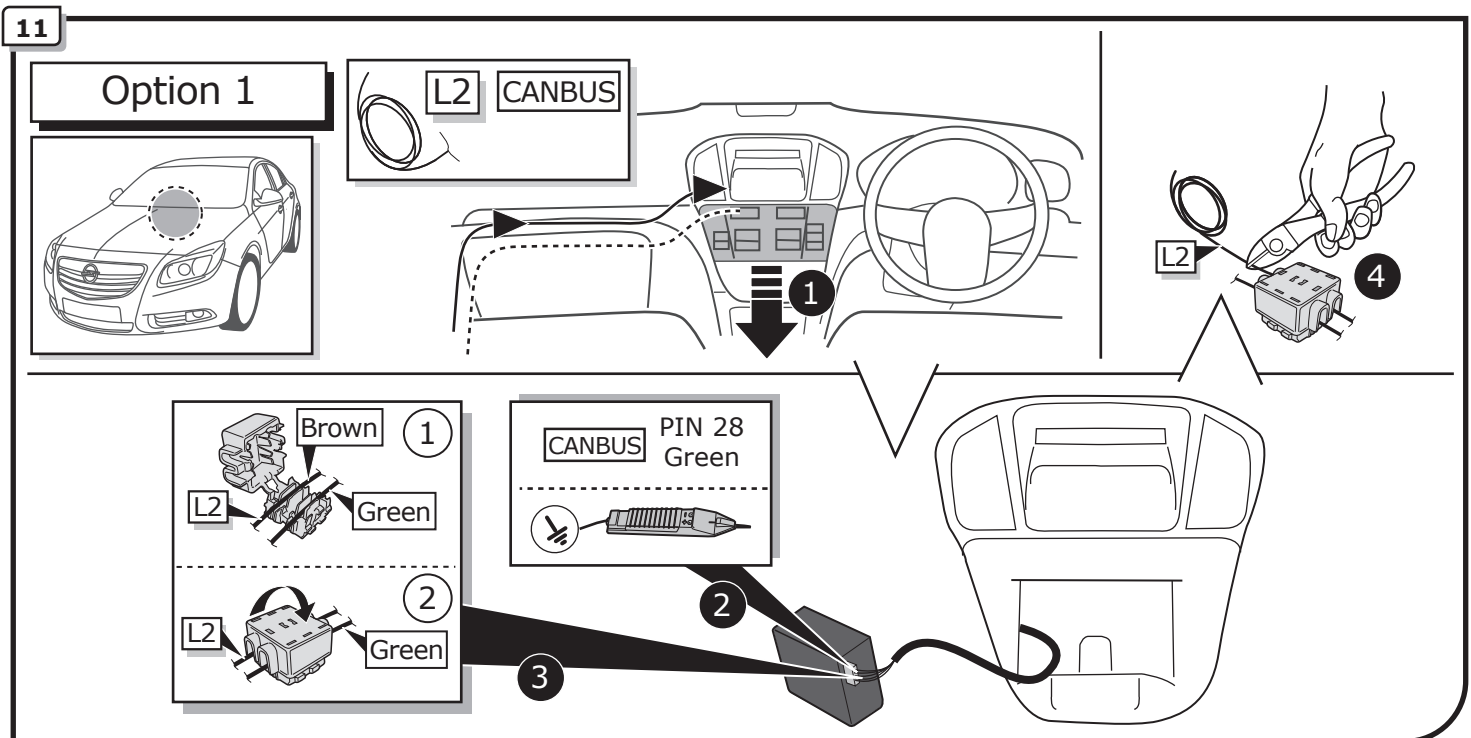
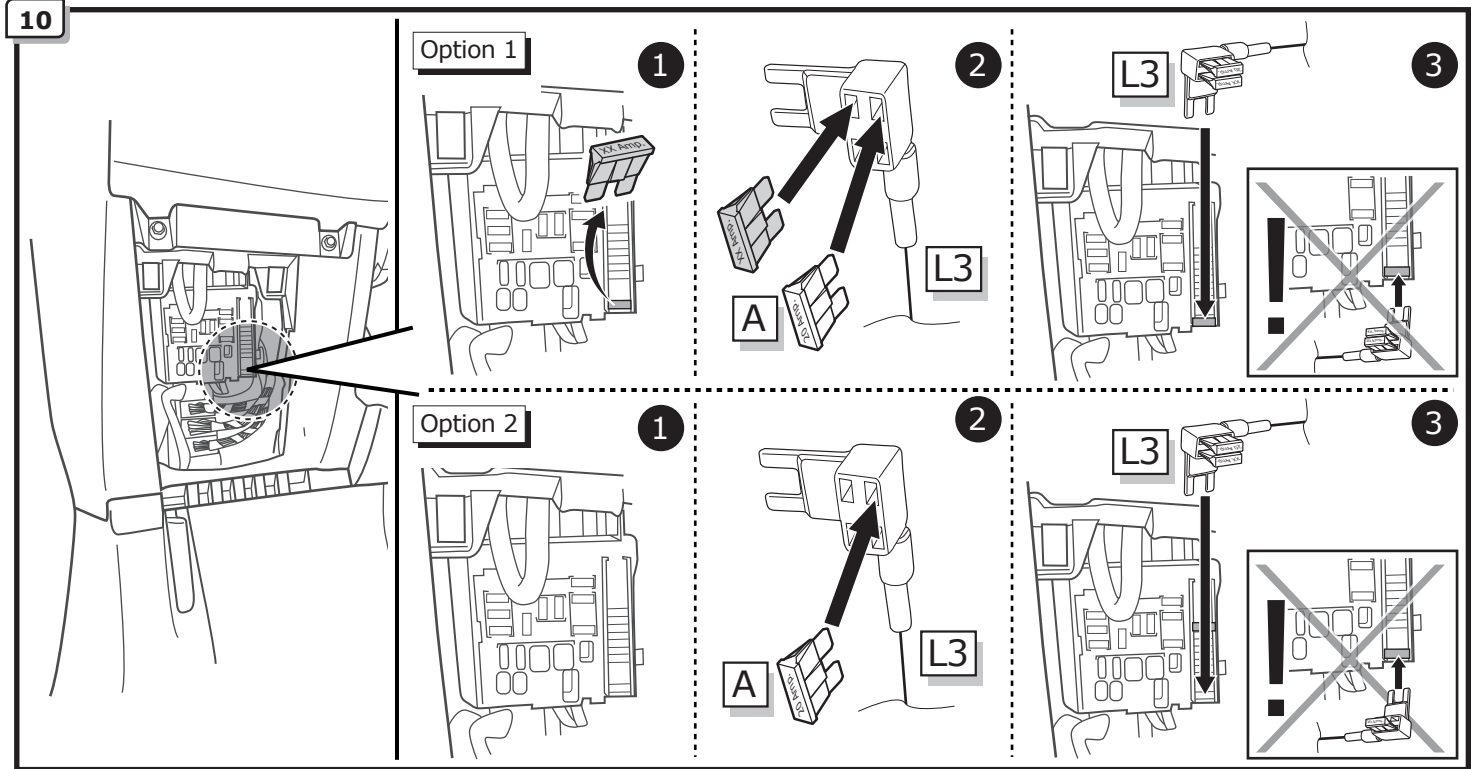
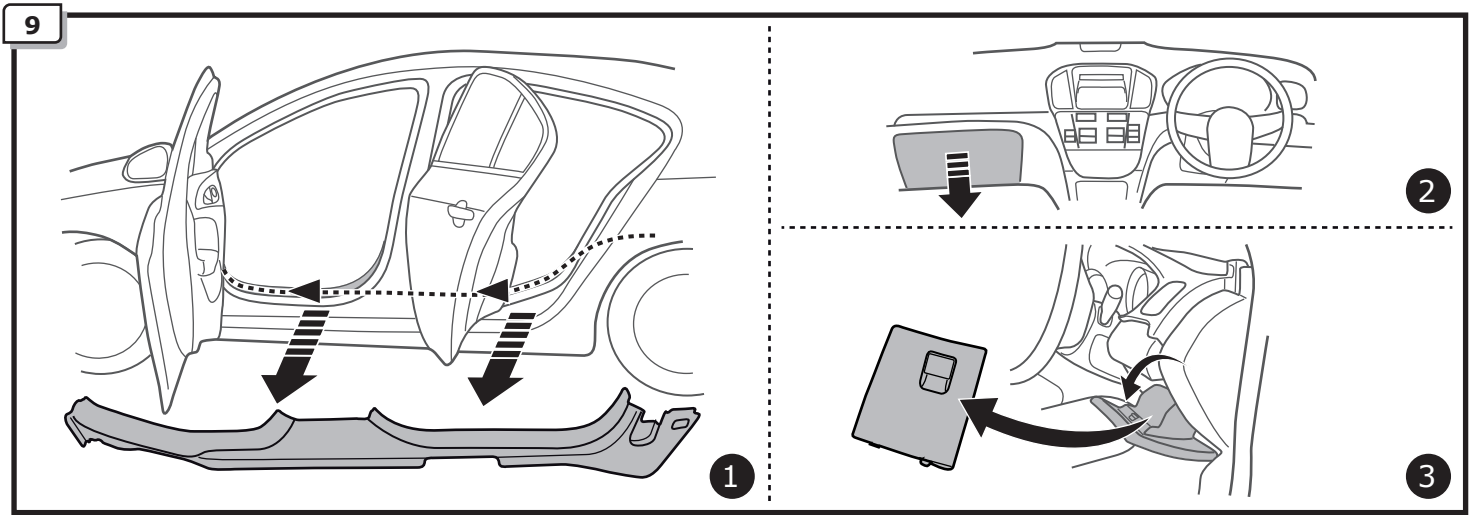

12

Option 2

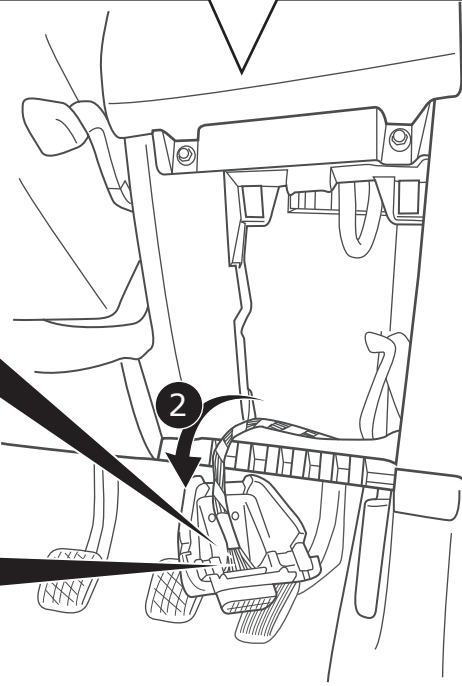
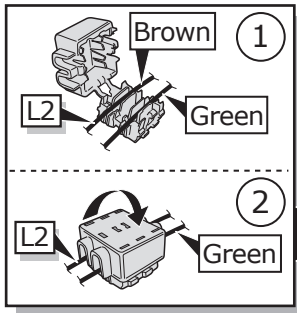
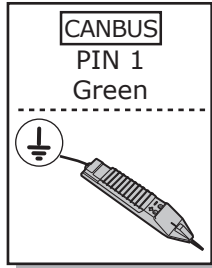
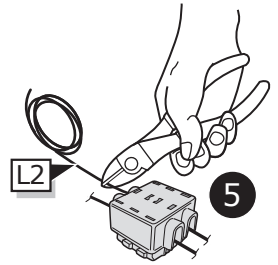
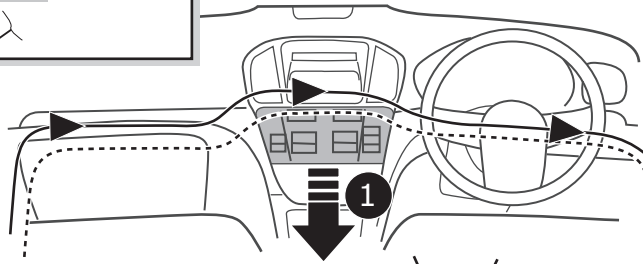
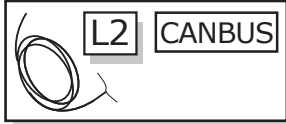
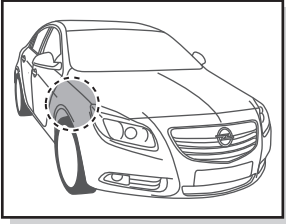

13



INFO

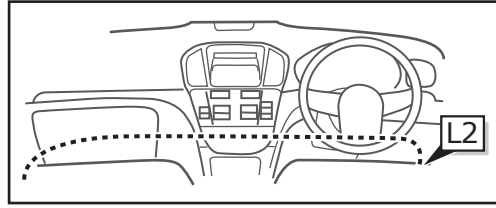
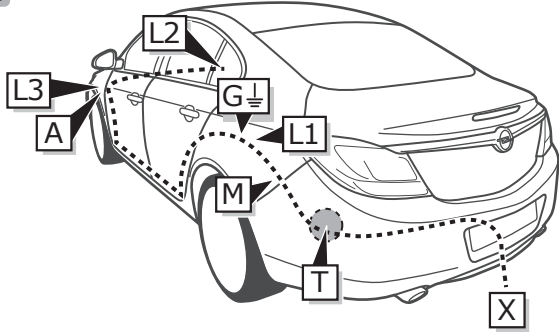

Insignia HB

Pag. 9

-
Pag. 12

1

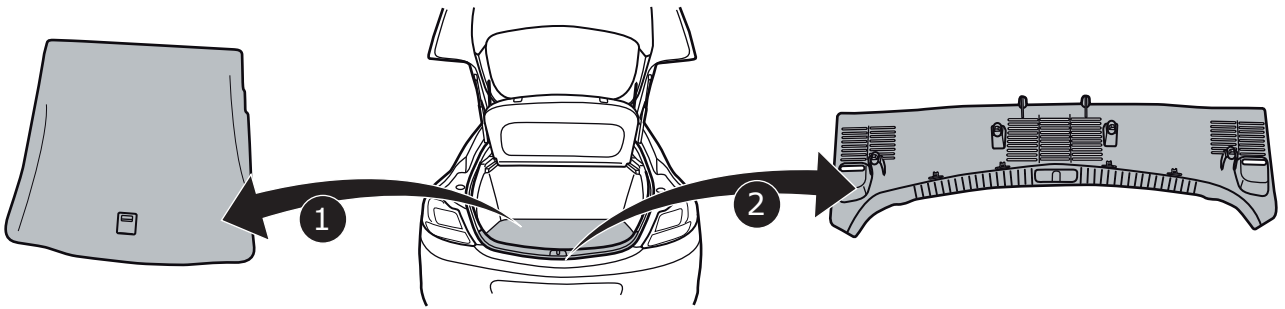

2

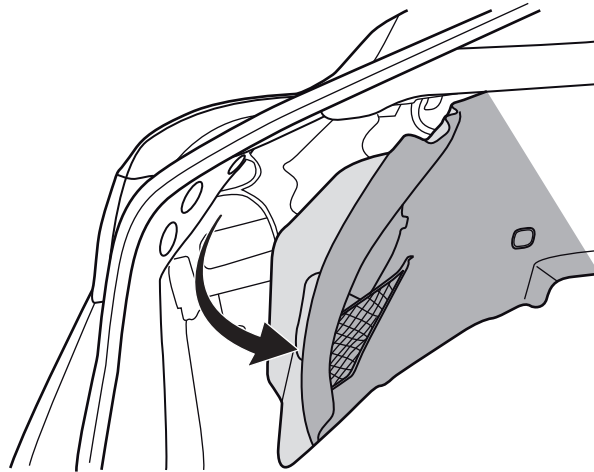

3

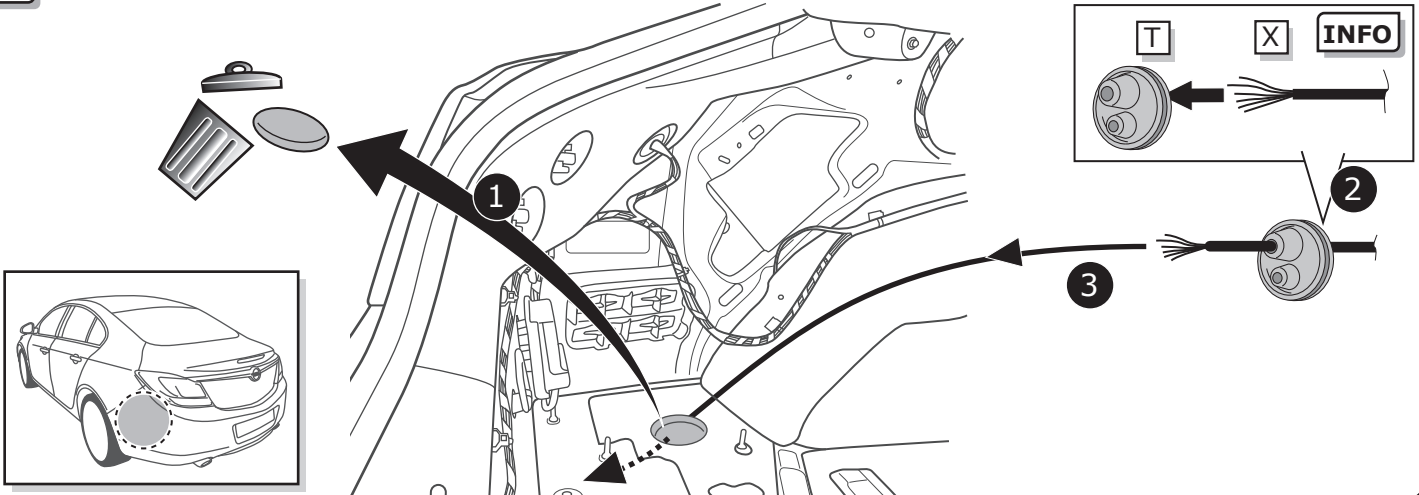

4



5

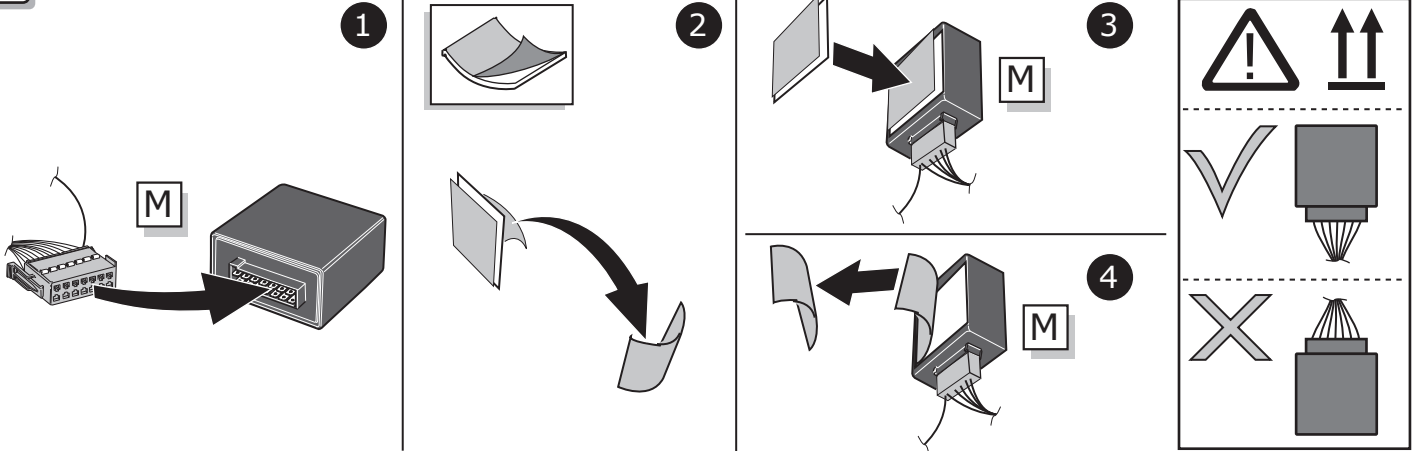

6

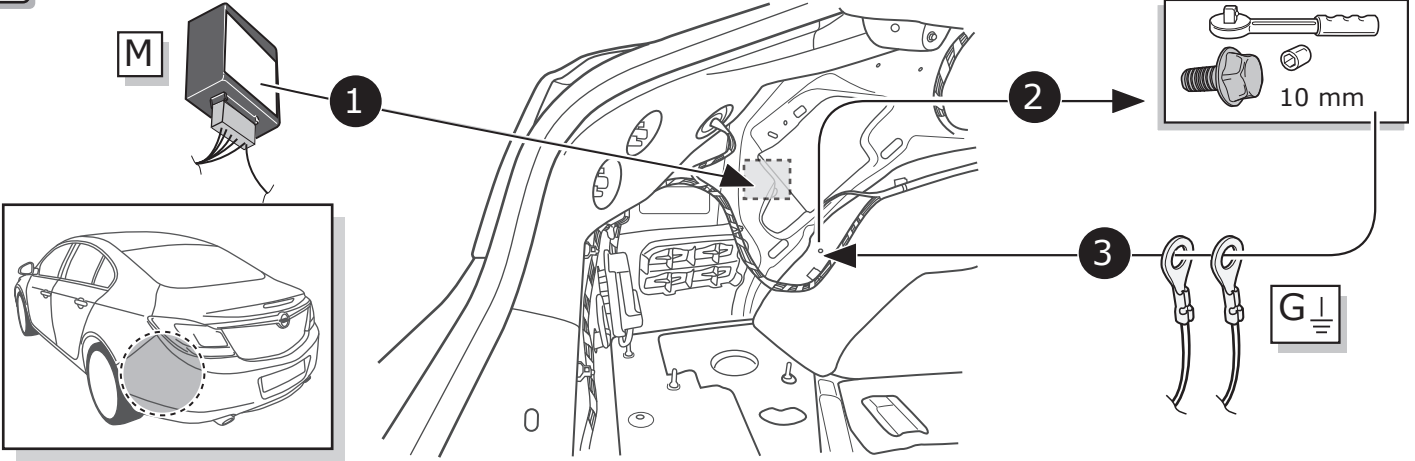

7

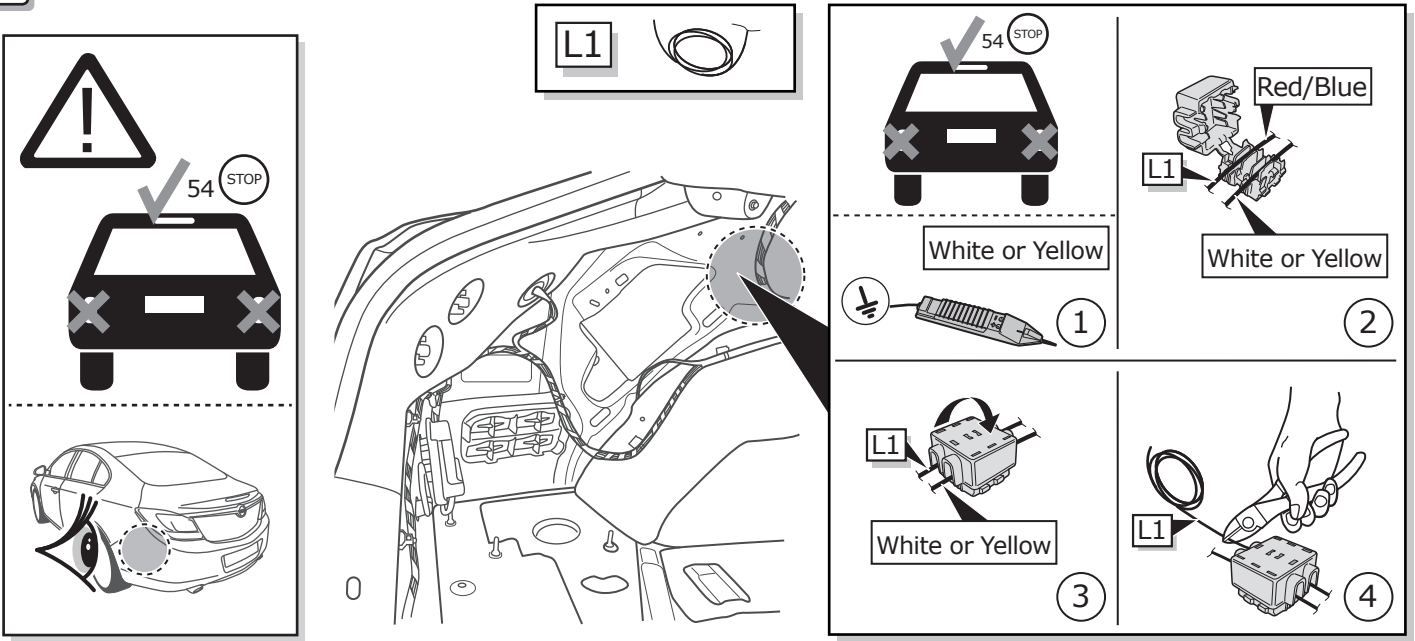

8

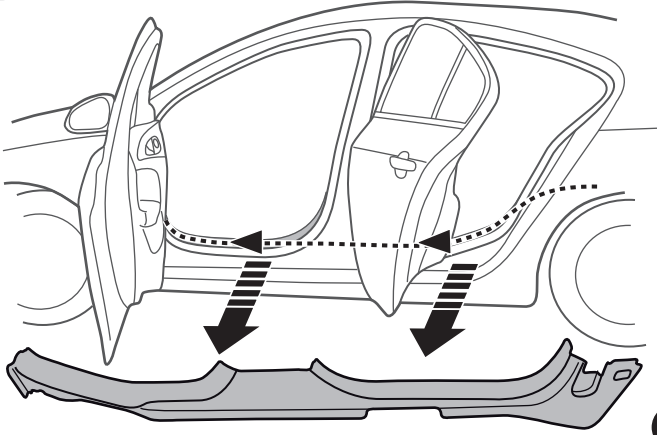

1

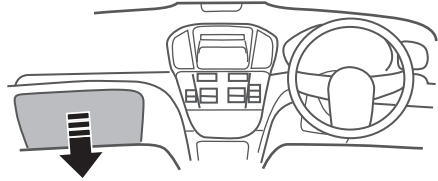

2

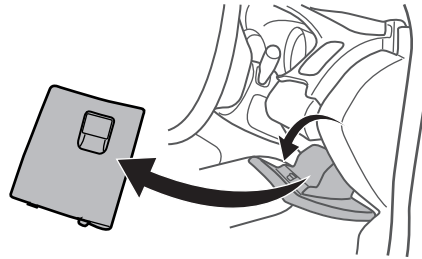

3

9

Option 1

1

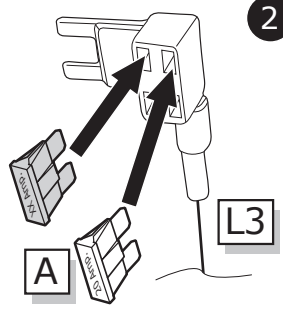
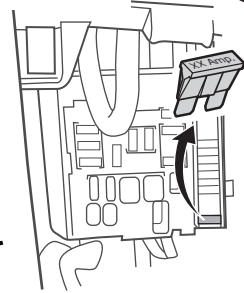

2

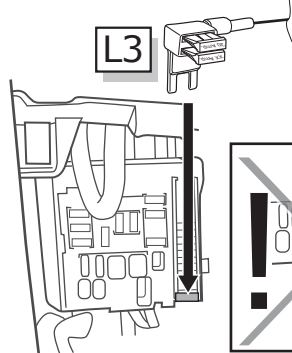

3

Option 2

1

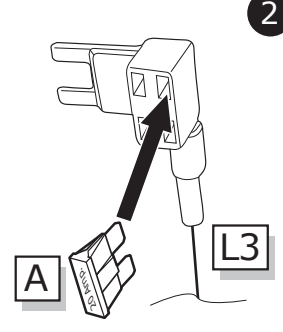
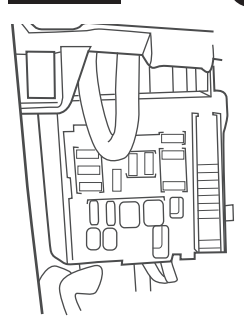

2

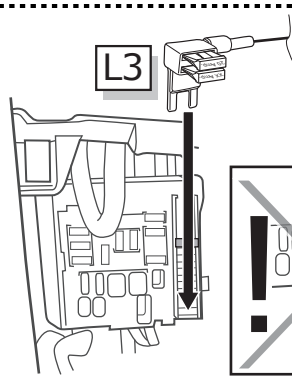

3

10

Option 1

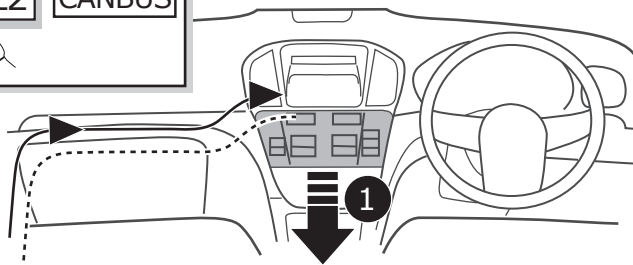
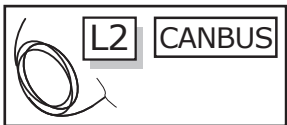
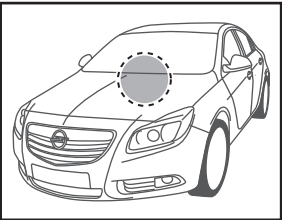

1

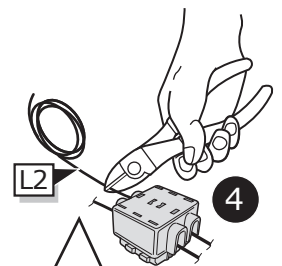

4

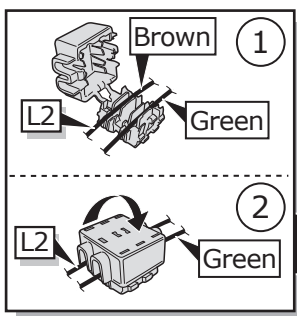

1

2

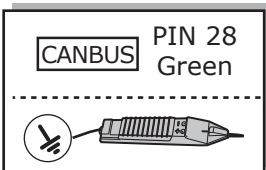

2

3



11

Option 2

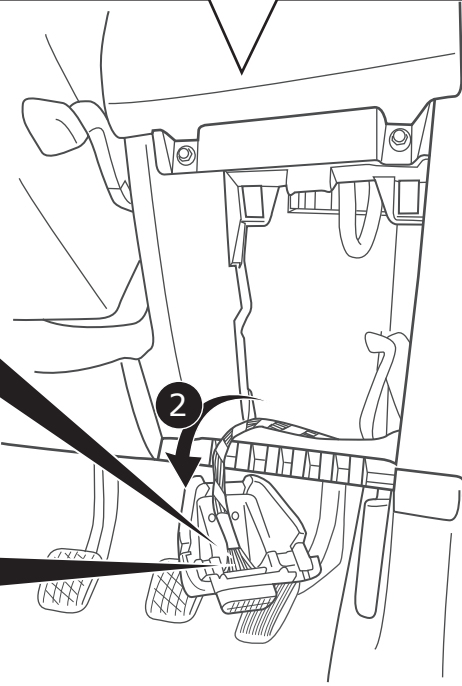
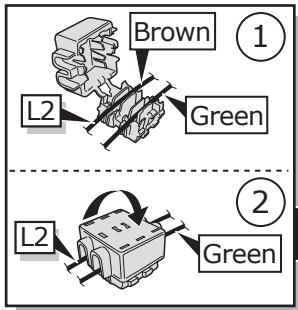
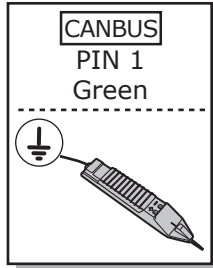
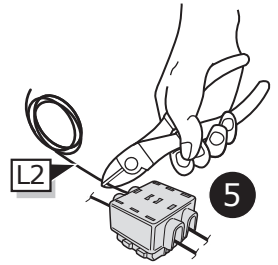
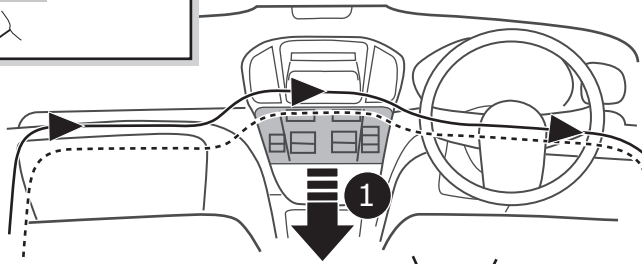
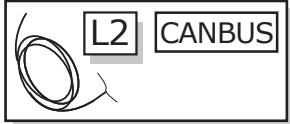
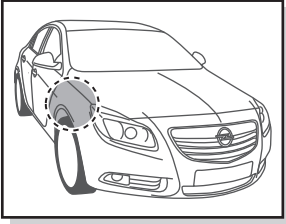

12



INFO

Insignia ST

Pag. 13

-
Pag. 17

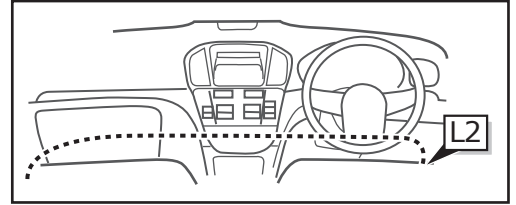
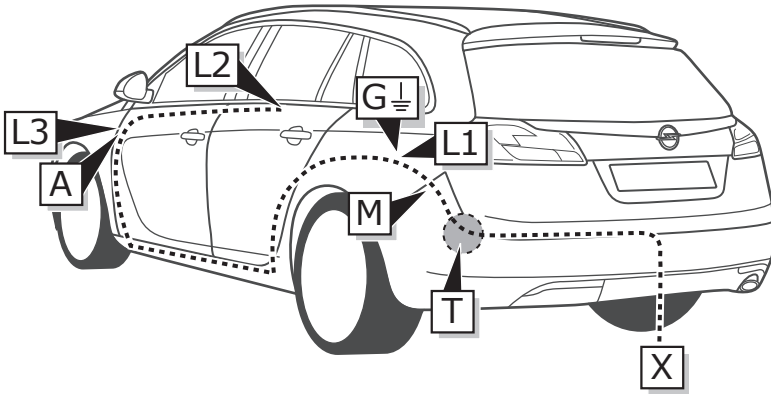

1

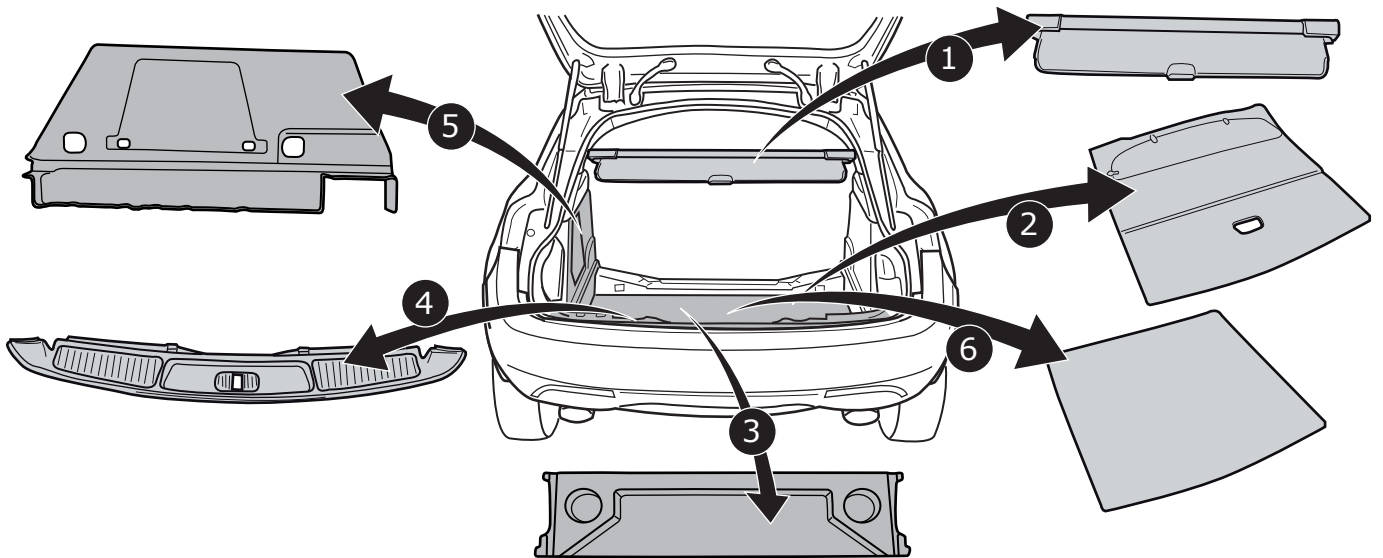

2

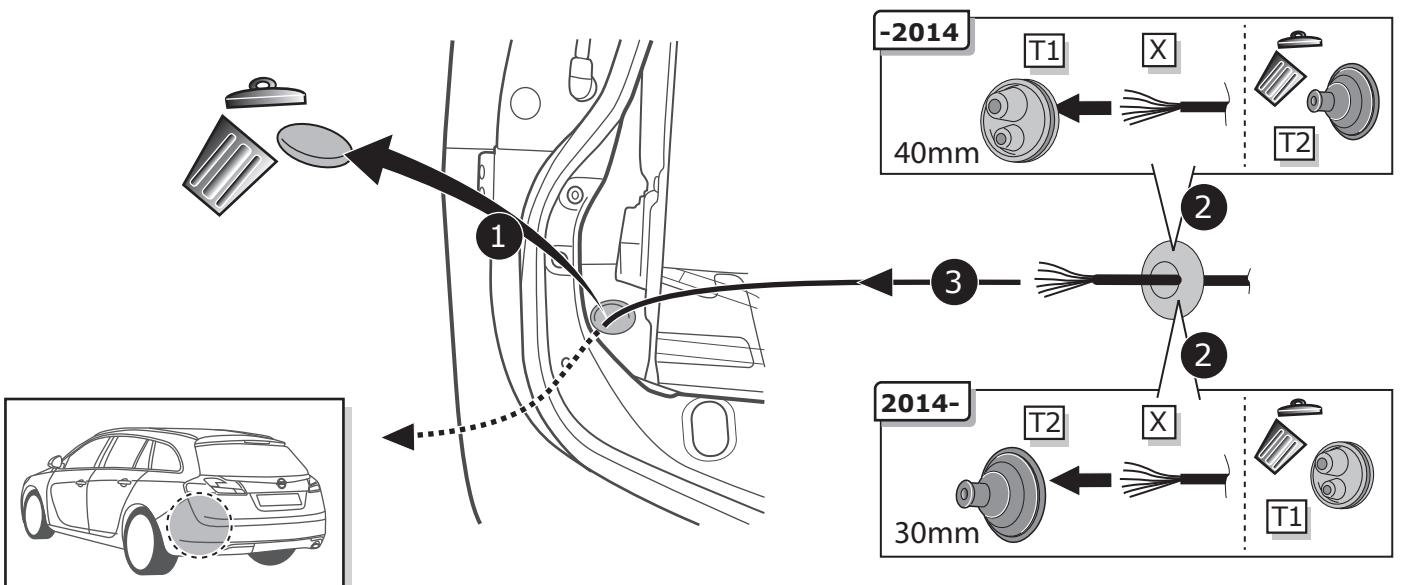

3



4

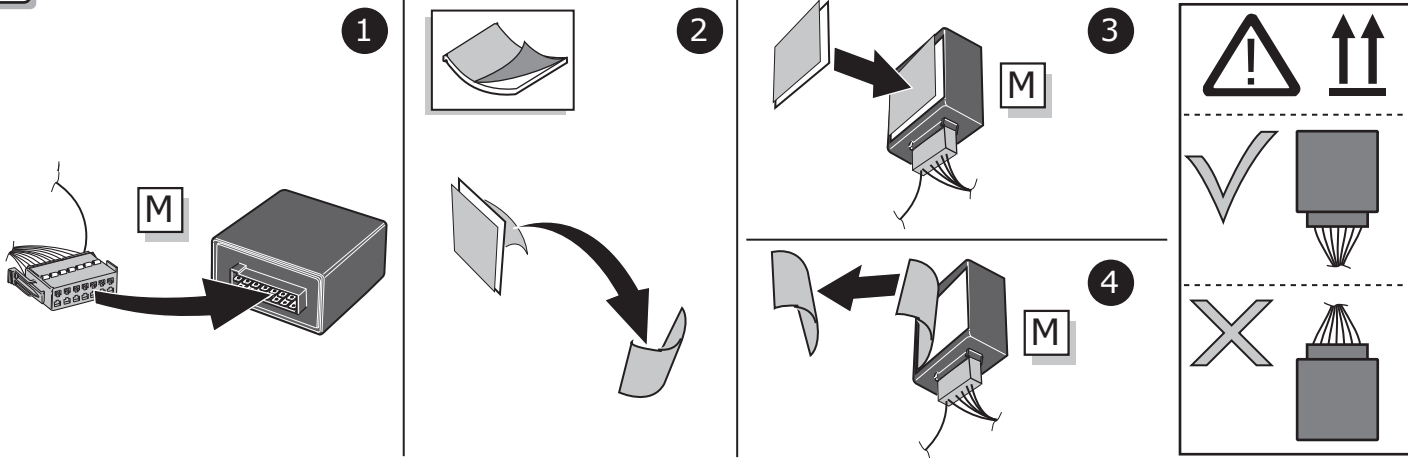

5

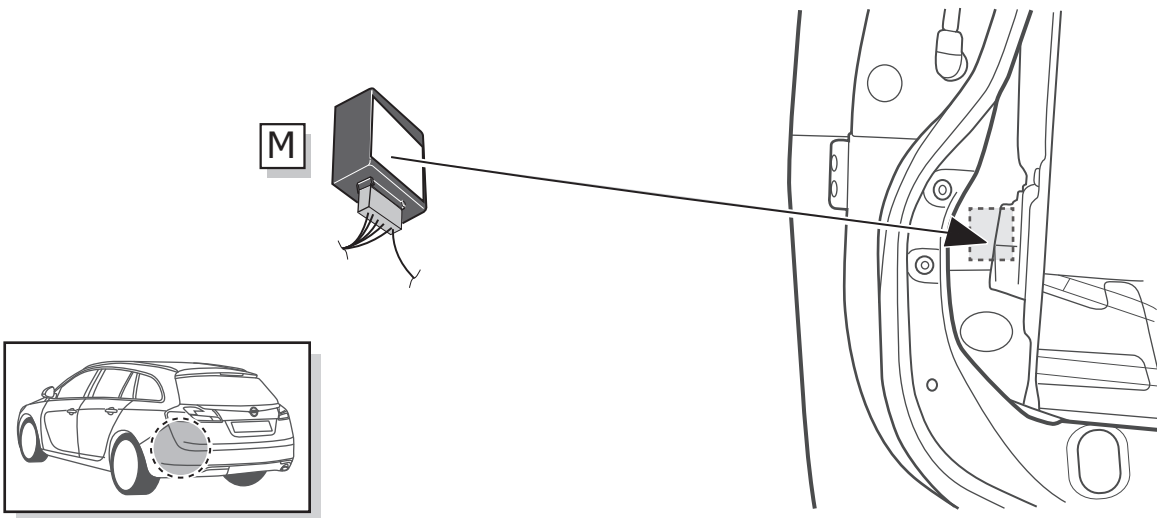

6

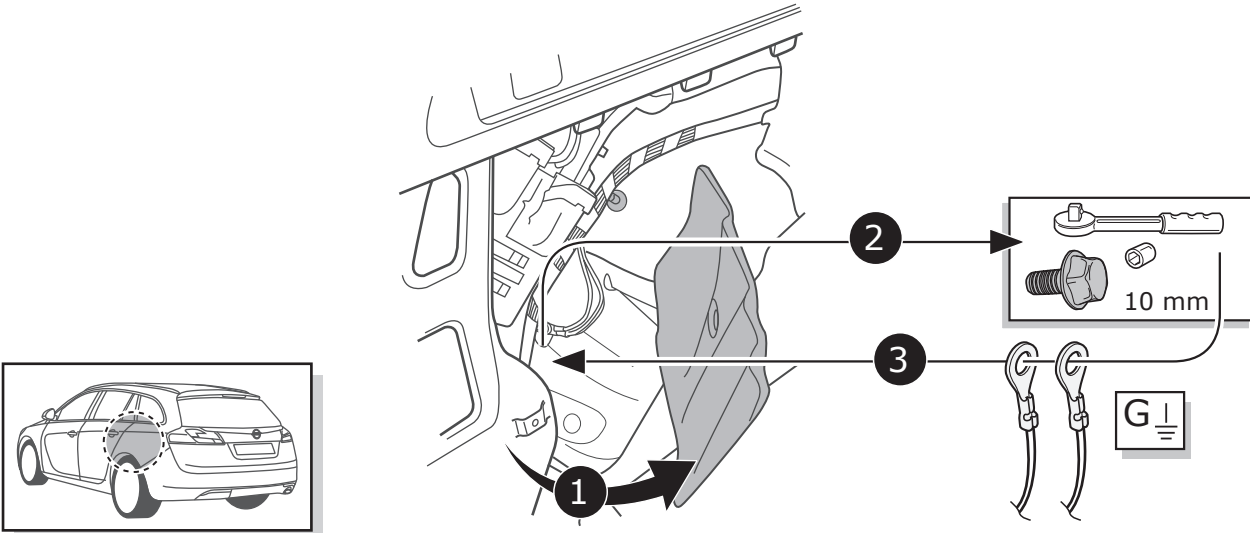

7

-2014

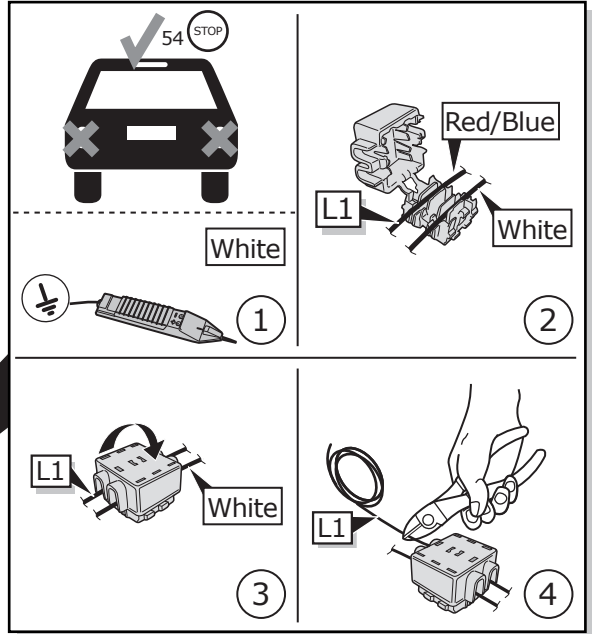
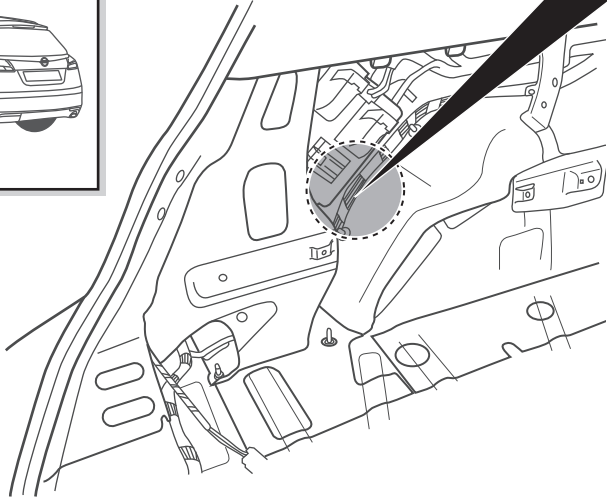
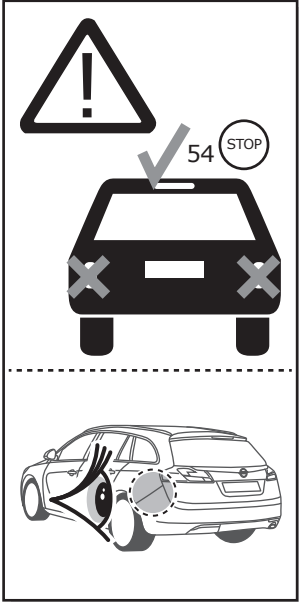

8

2014-

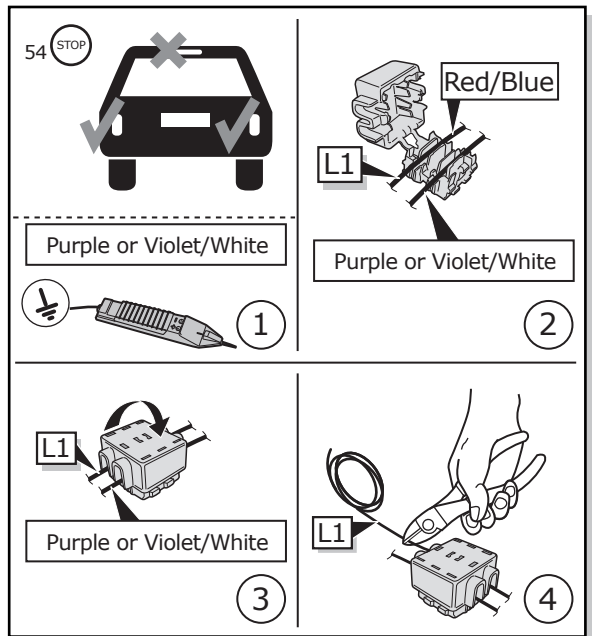
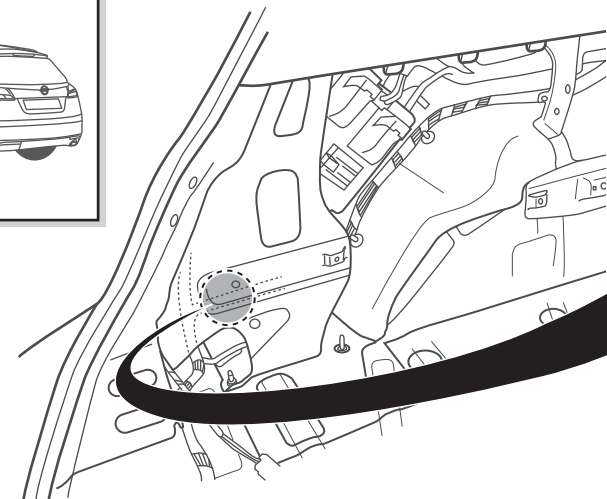
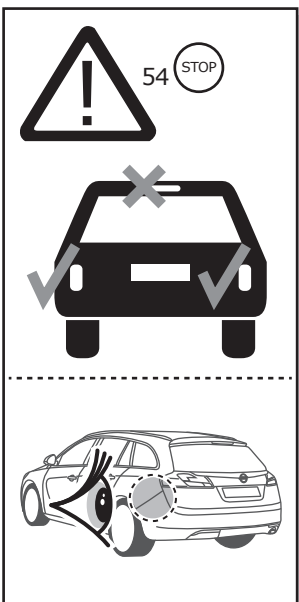

9

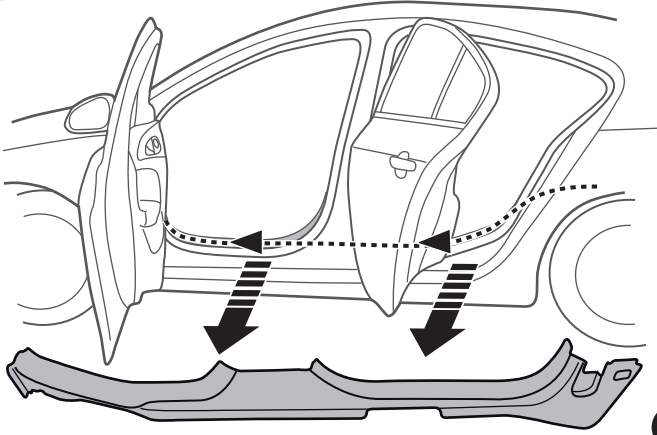

1

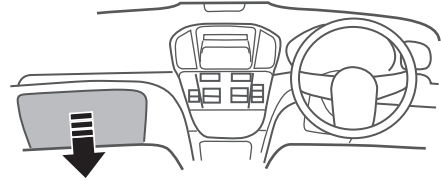

2

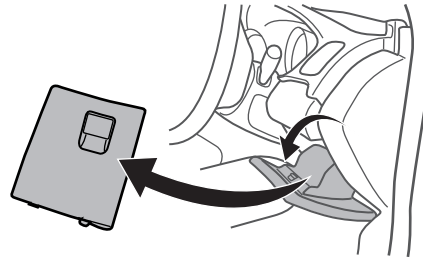

3

10

Option 1

1

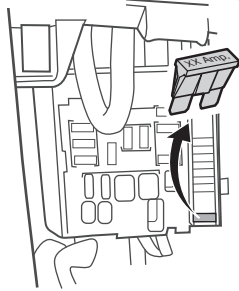

2

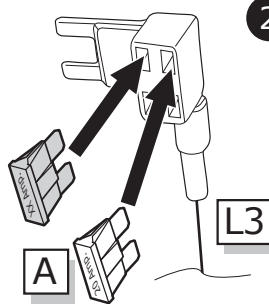

3

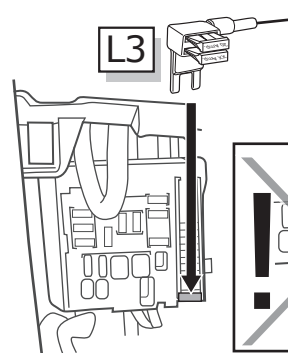

Option 2

1

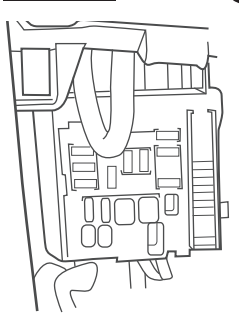

2

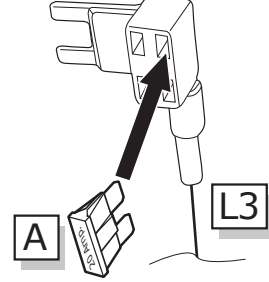

3

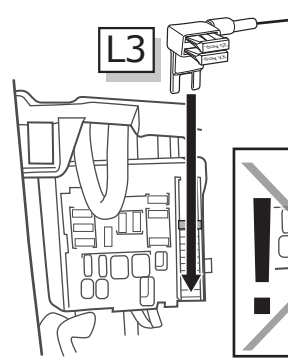

11

Option 1

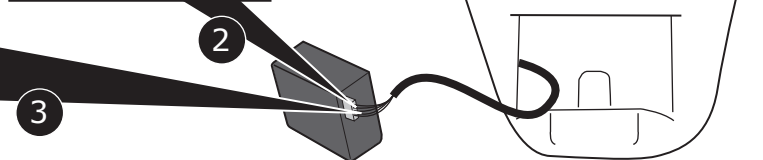
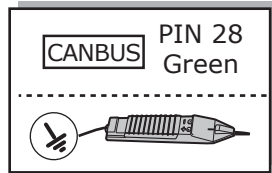
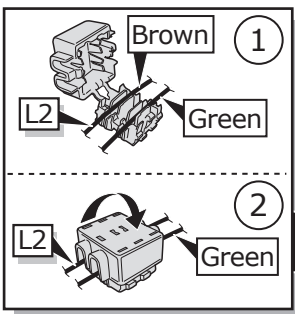
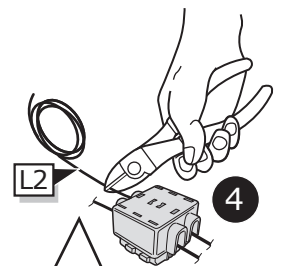
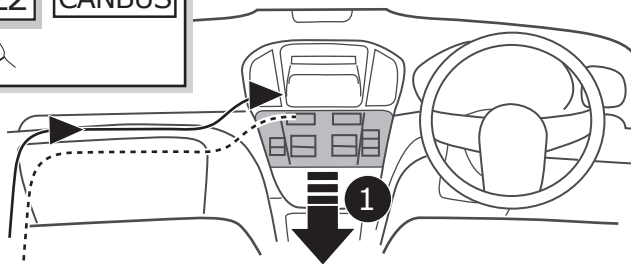
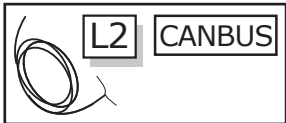
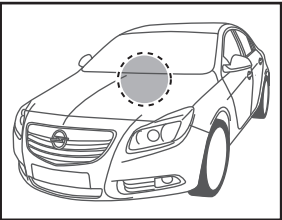

12

Option 2

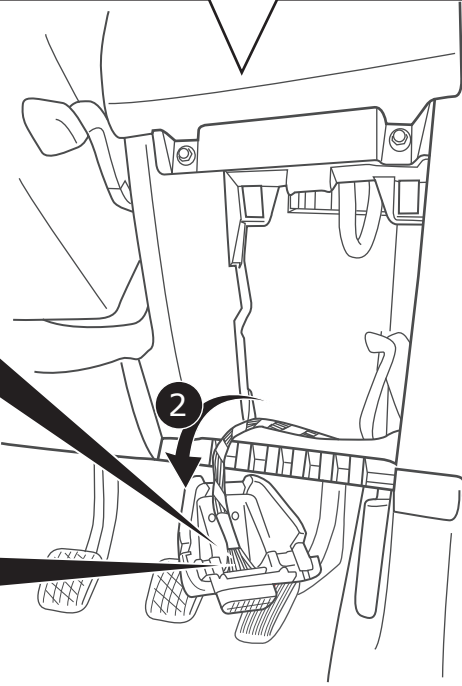
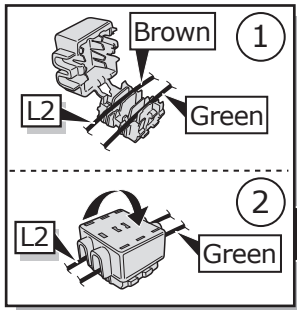
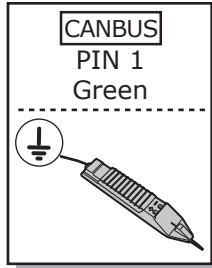
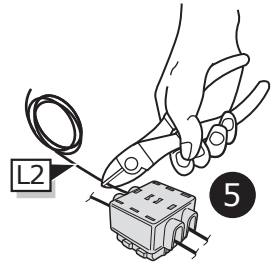
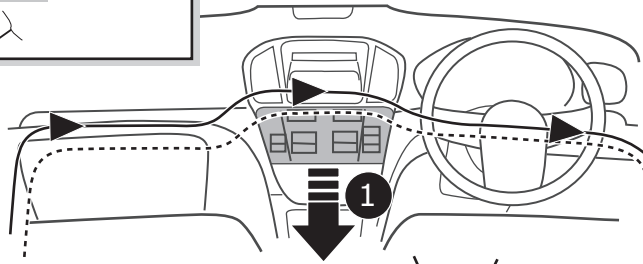
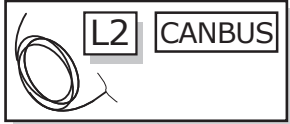
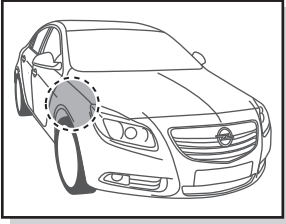

13



INFO

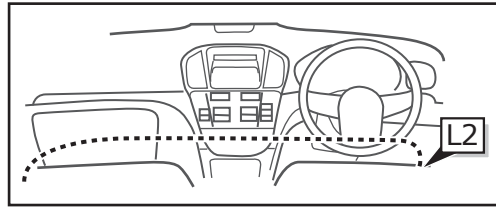
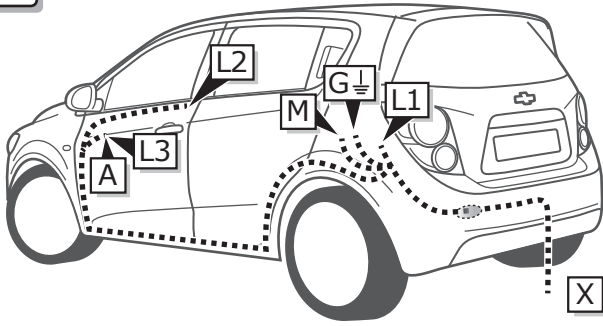

Aveo HB

Pag. 18

-
Pag. 20

1

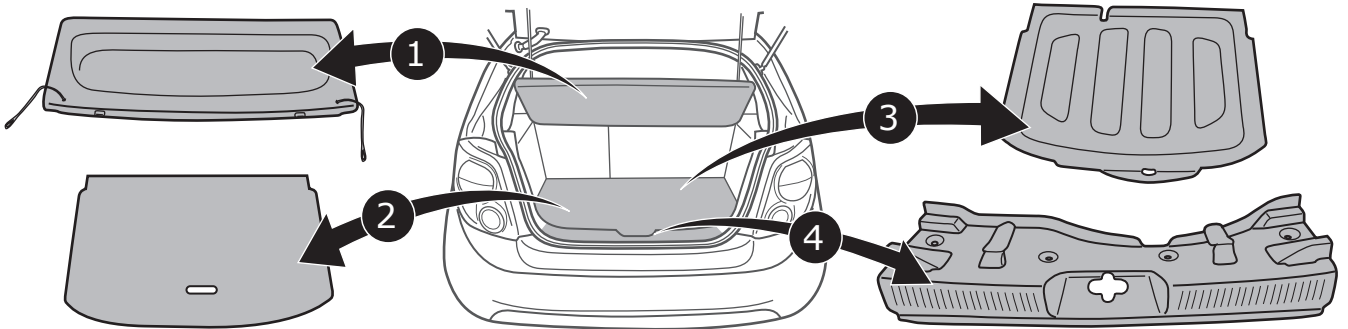

2

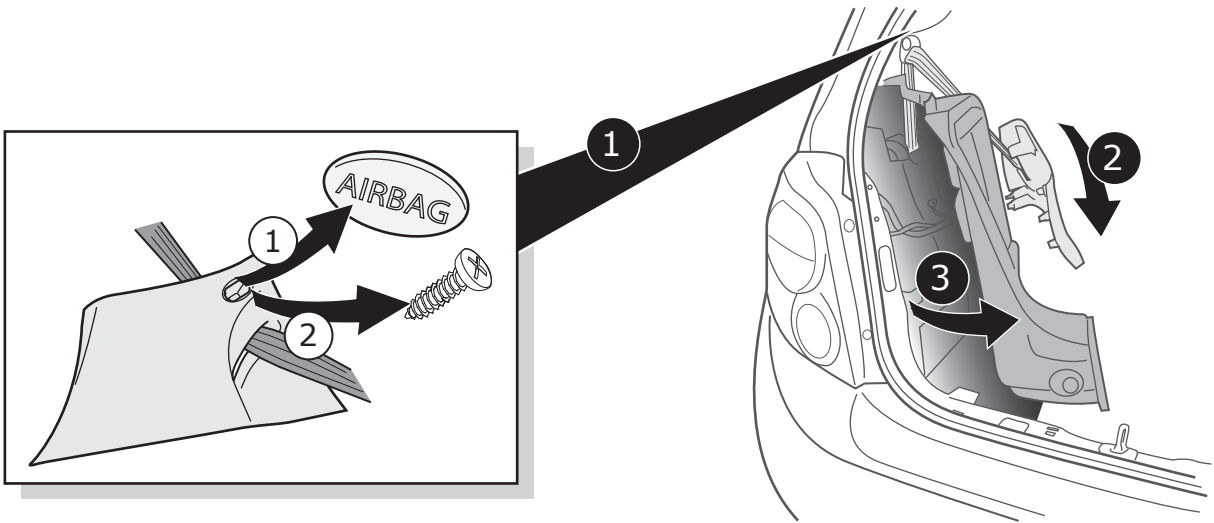

3

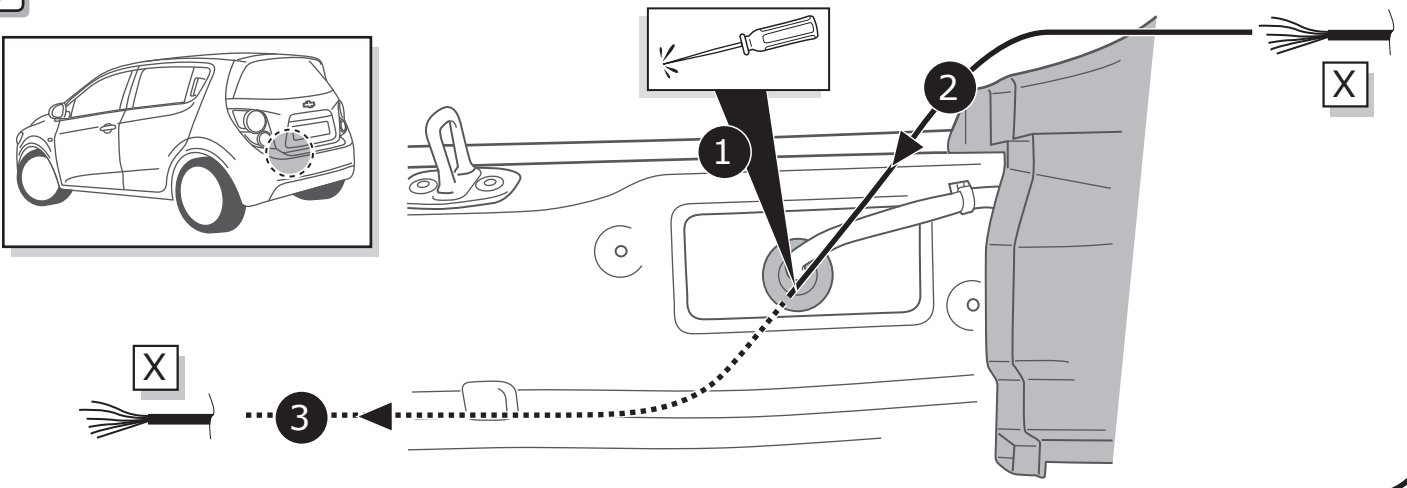

4



Pag. 34

5

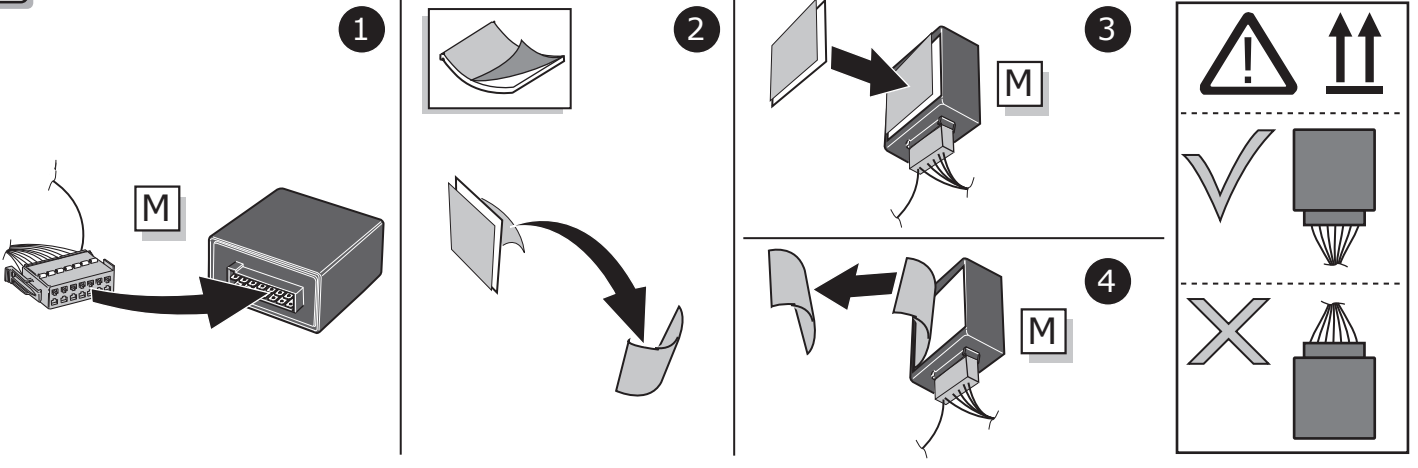

6

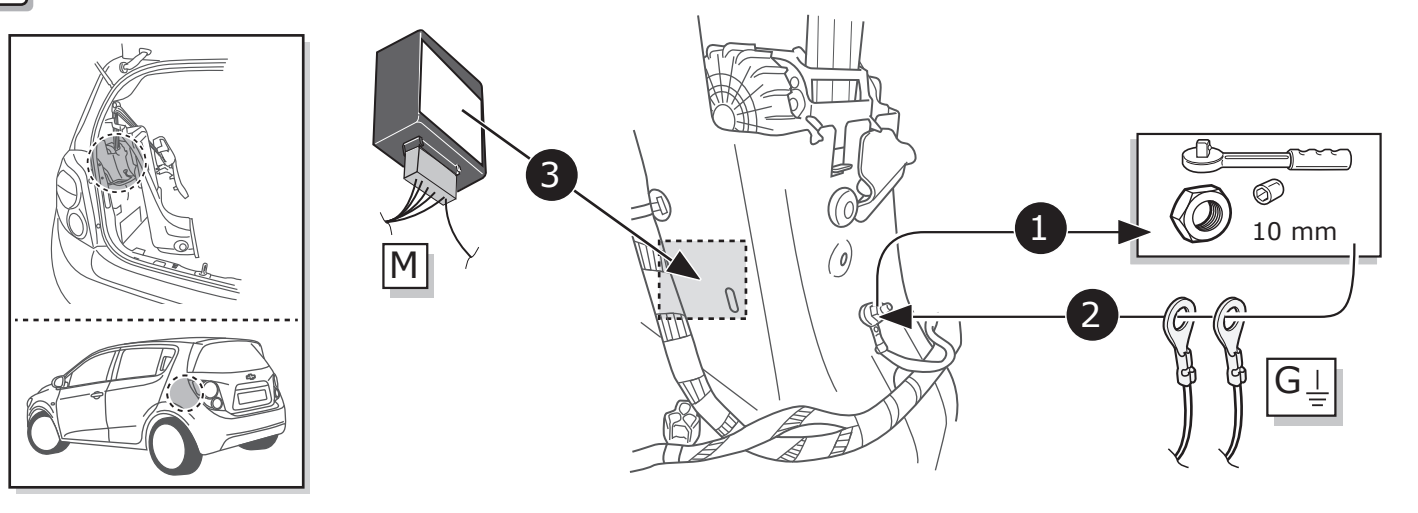

7

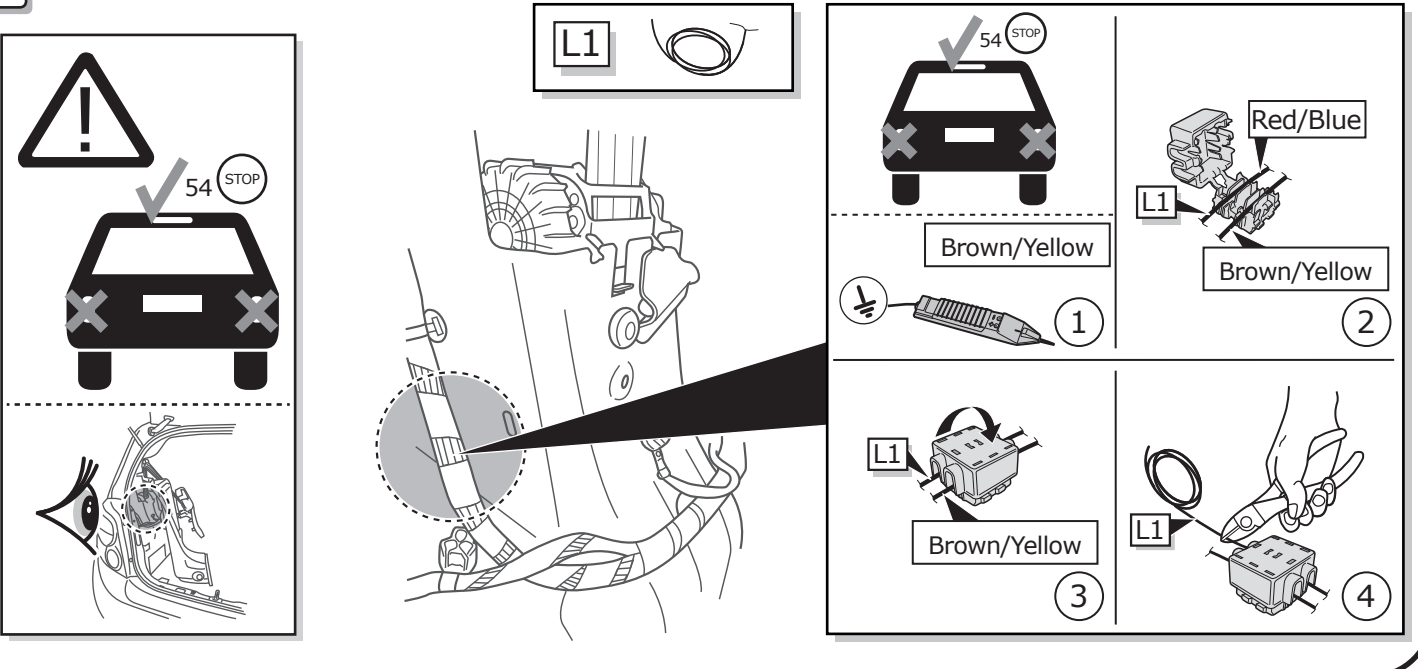

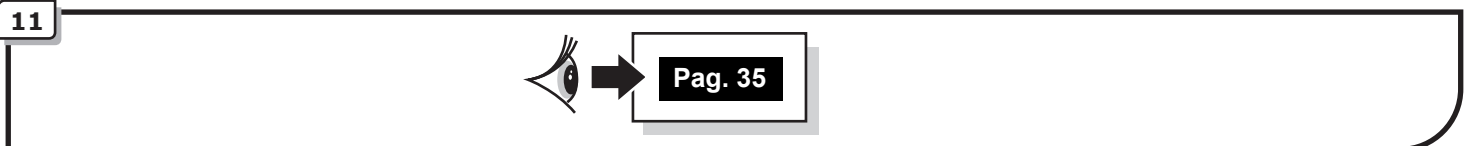
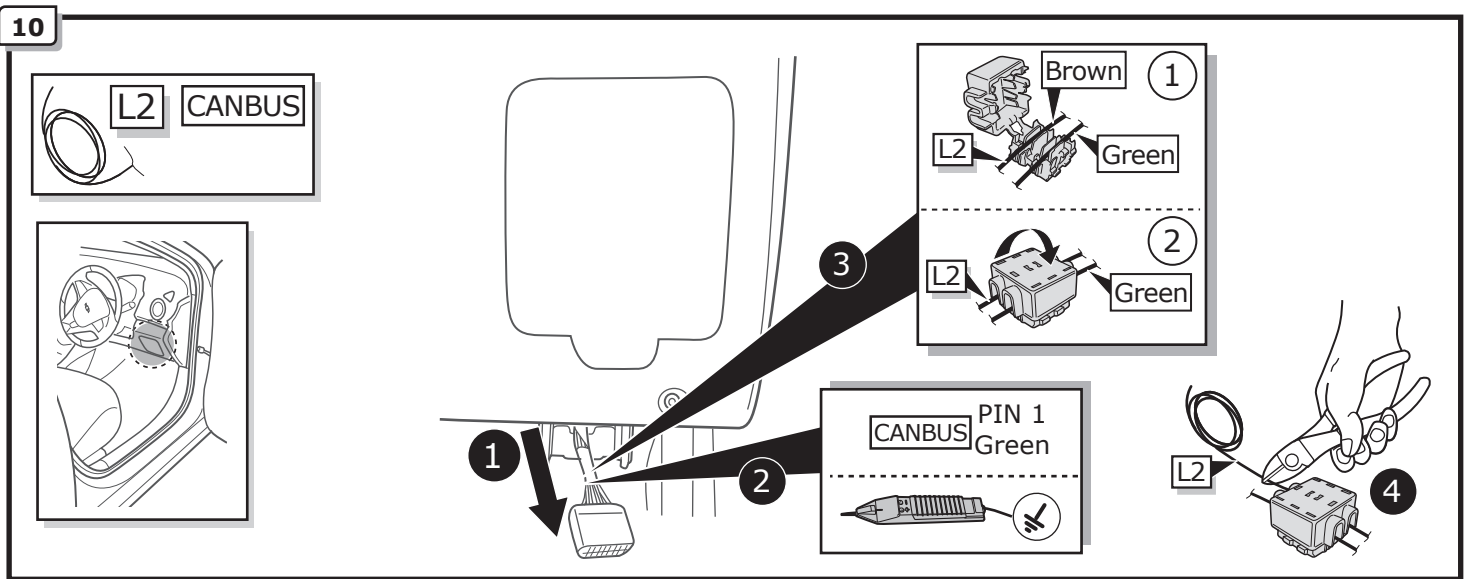
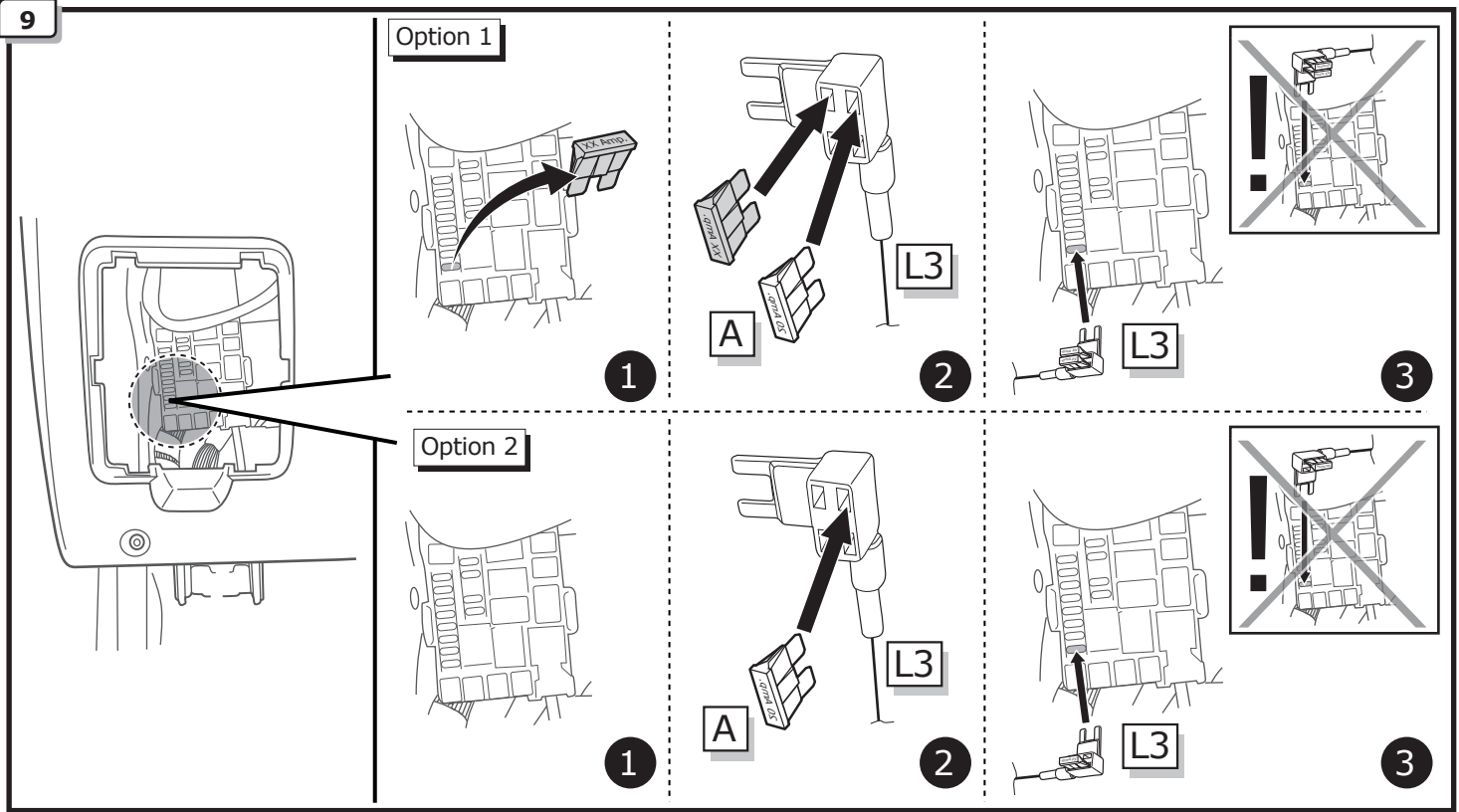
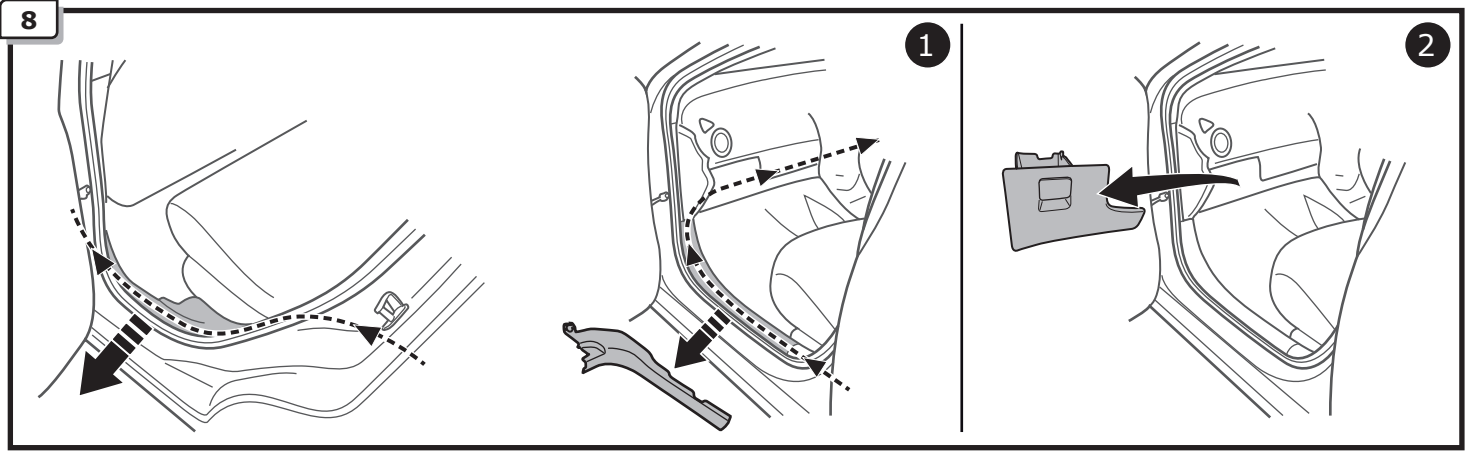

INFO

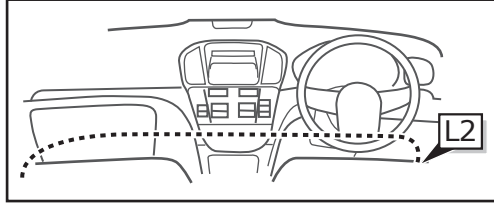
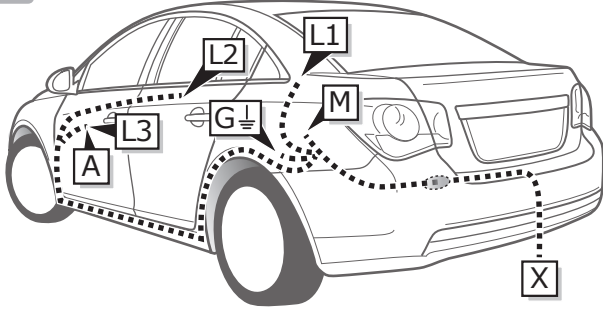

Aveo SD

Pag. 21

Pag. 23

1

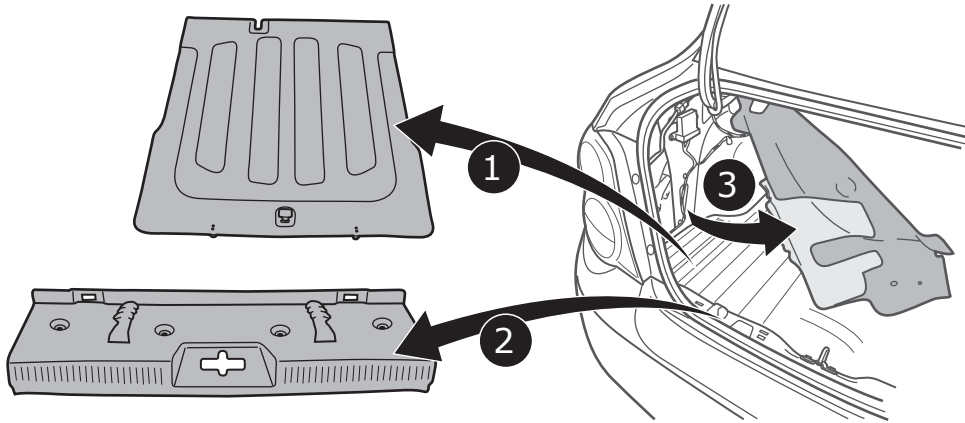

2

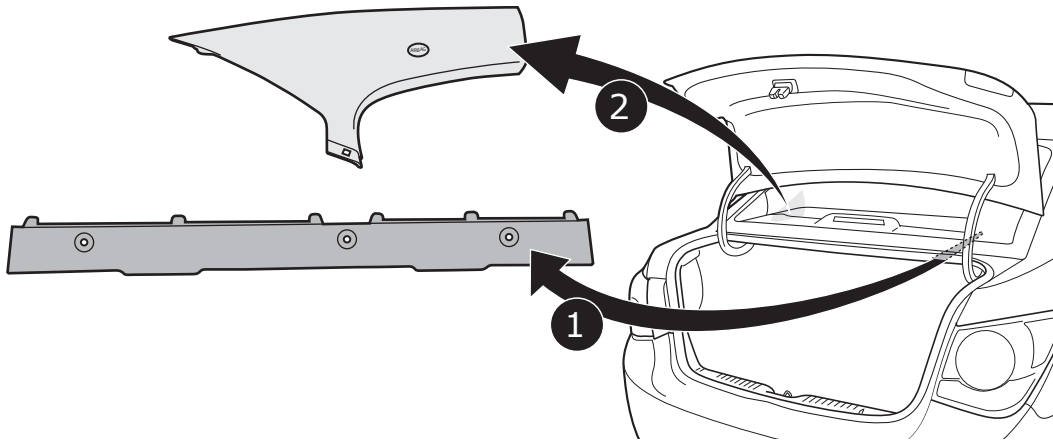

3

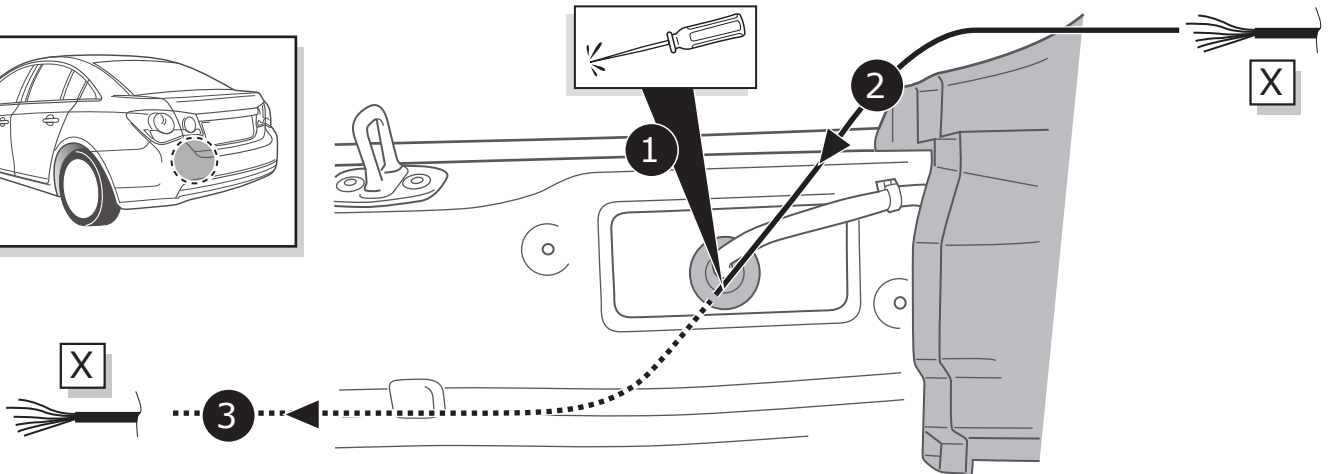
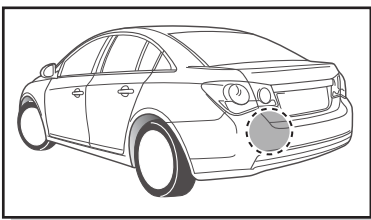

4



Pag. 34

5

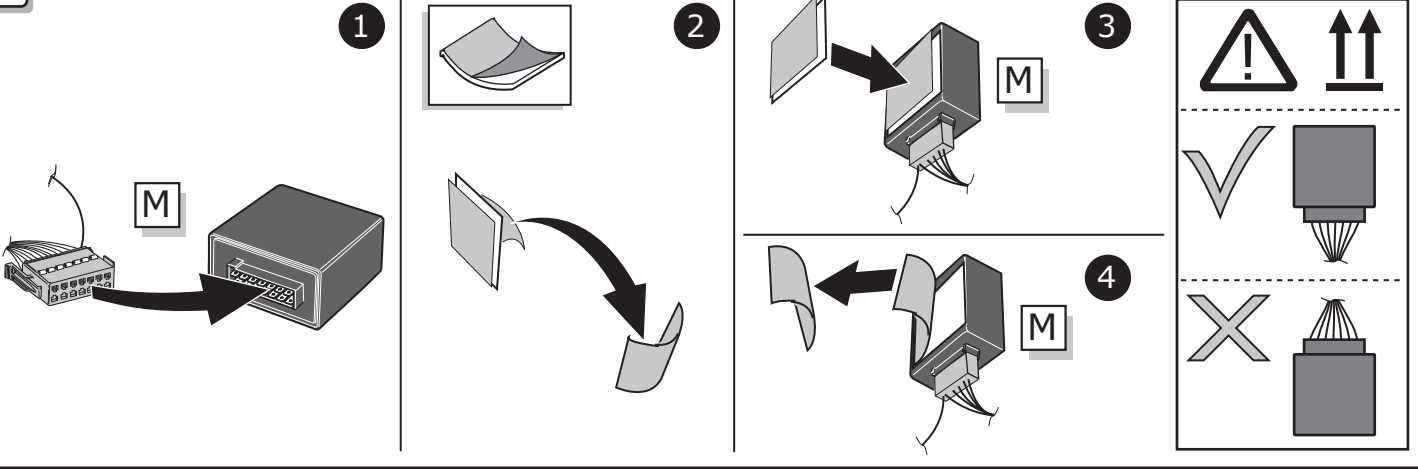

6

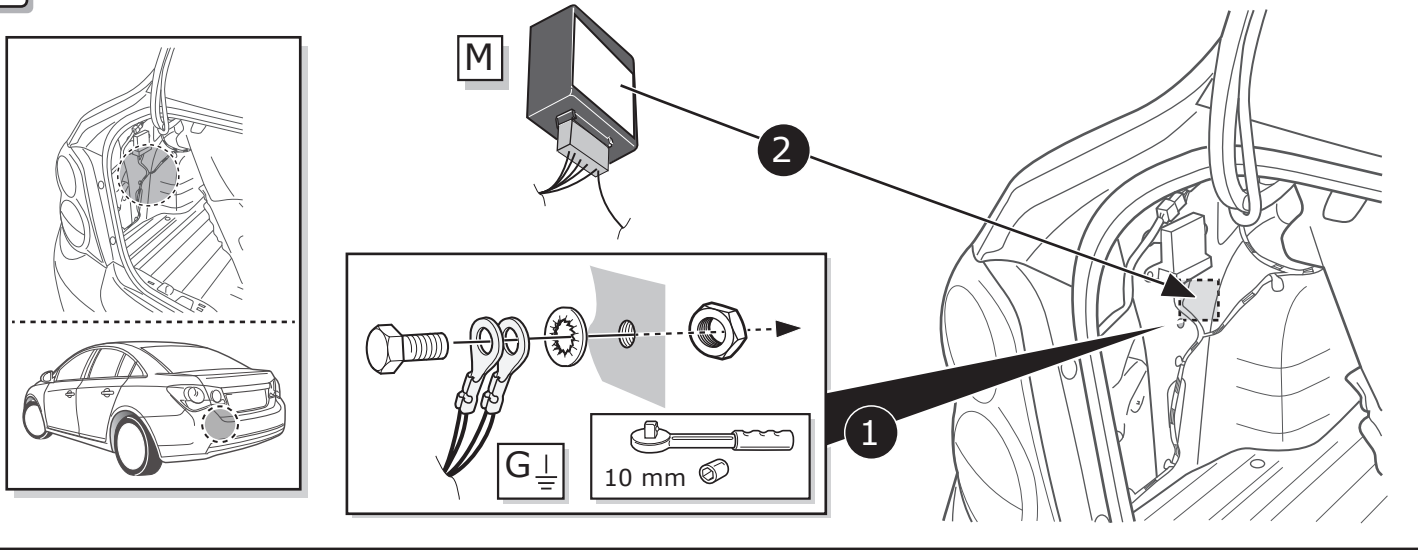

7

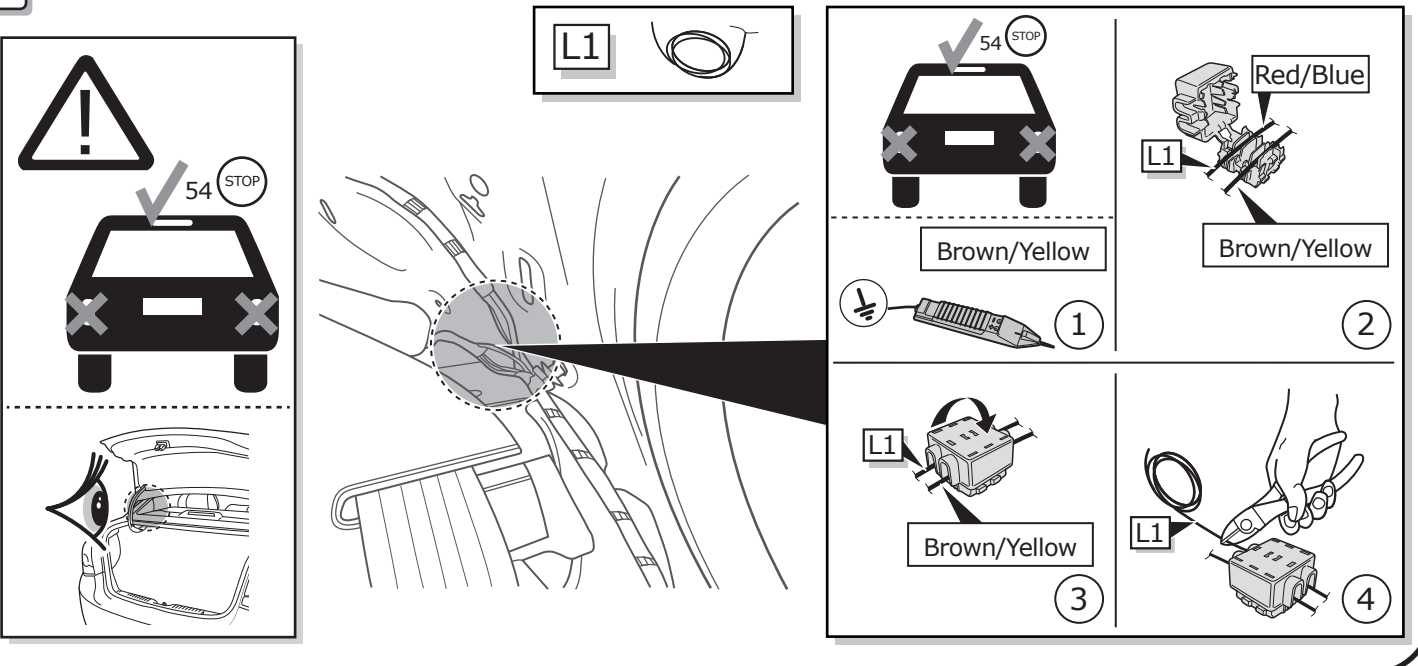

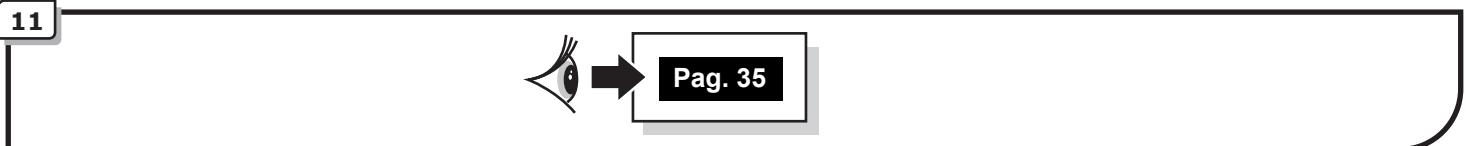
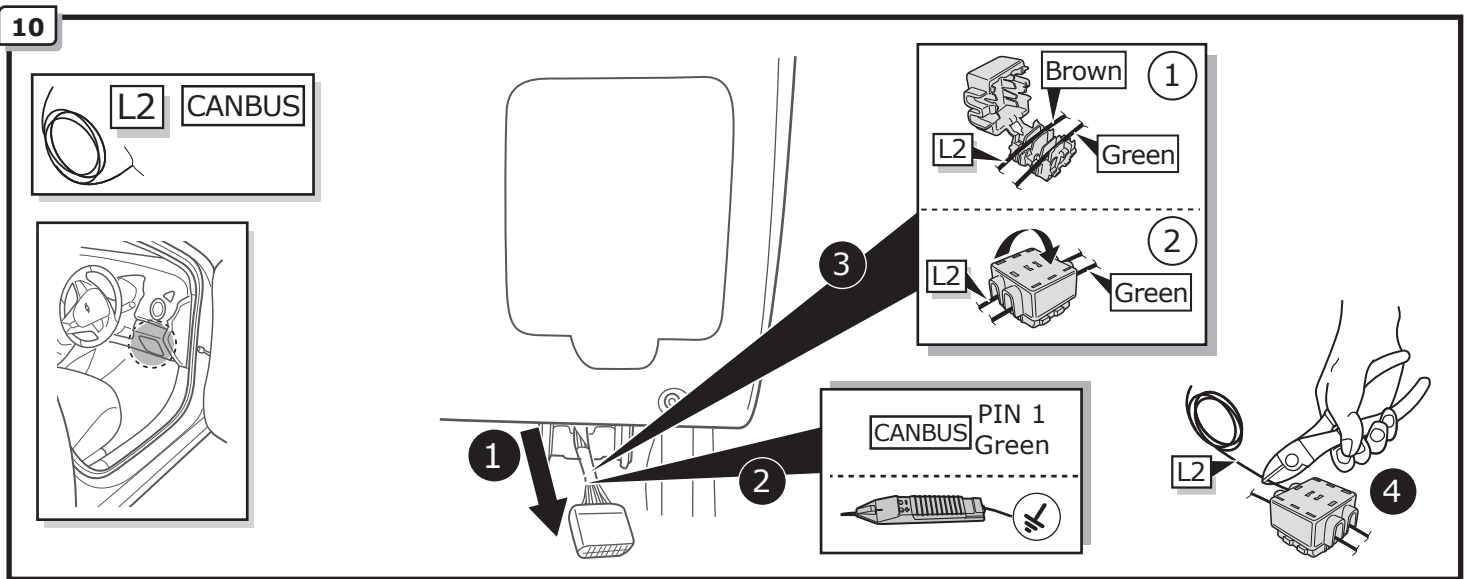
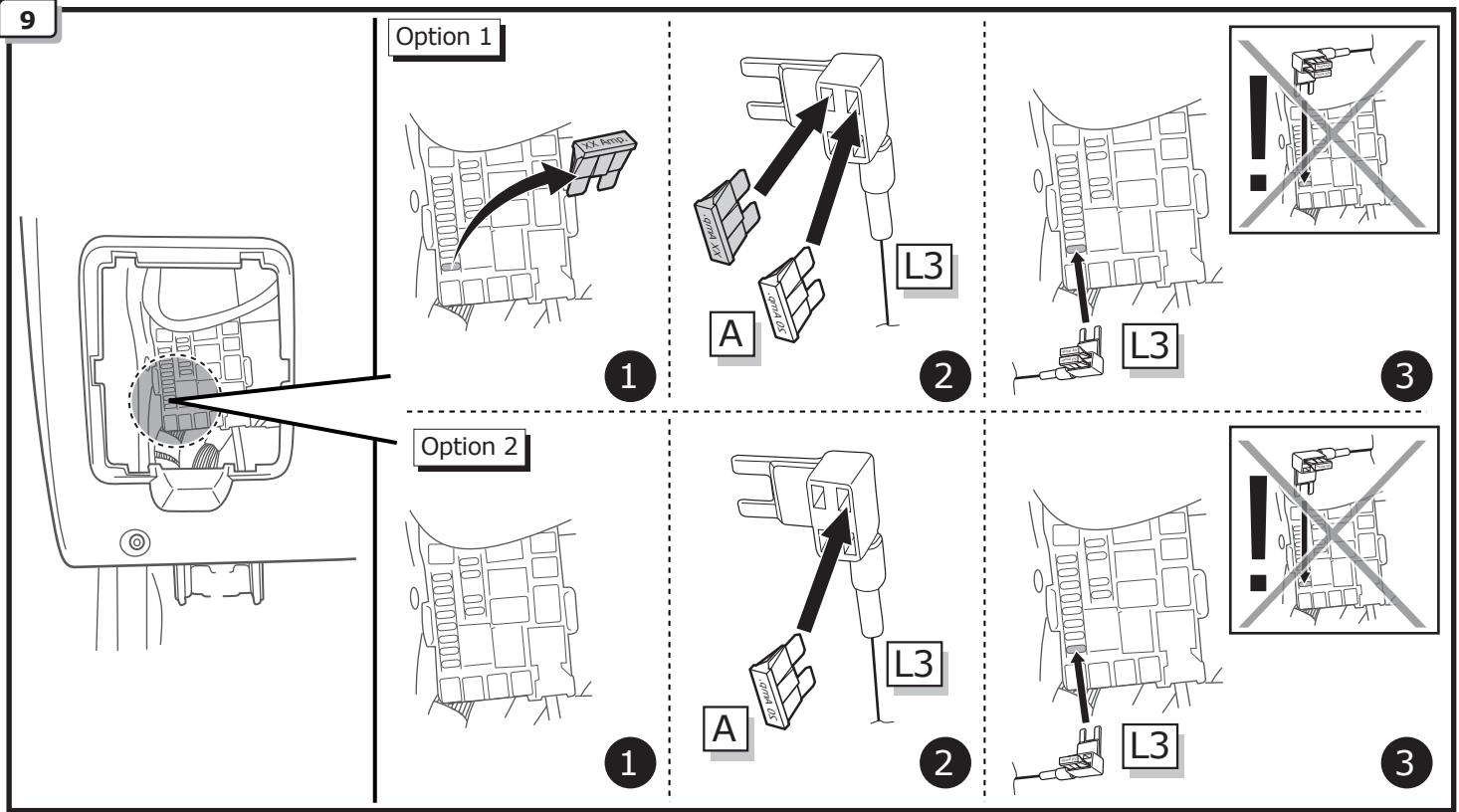
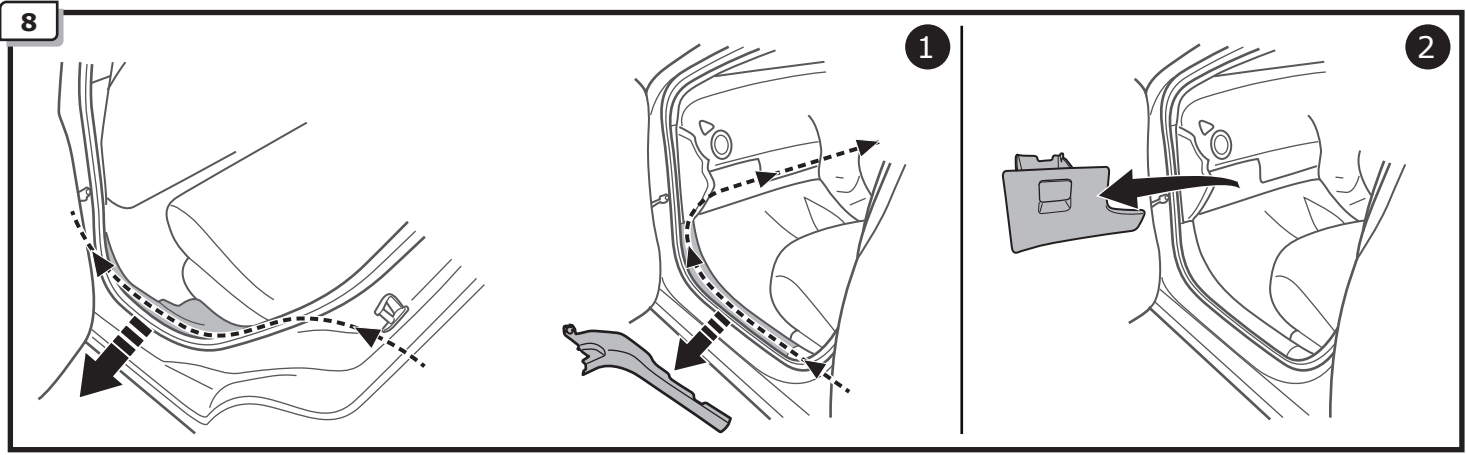

INFO

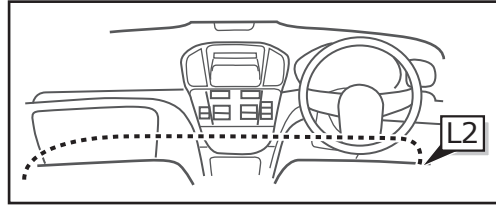
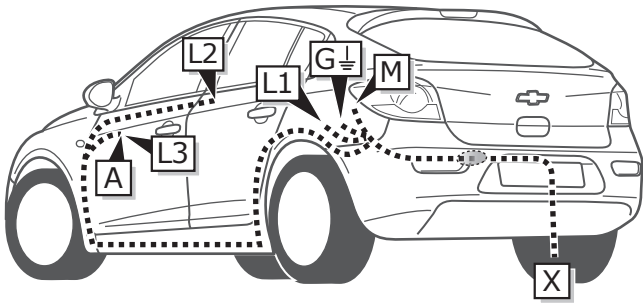

Cruze HB

Pag. 24

Pag. 26

1

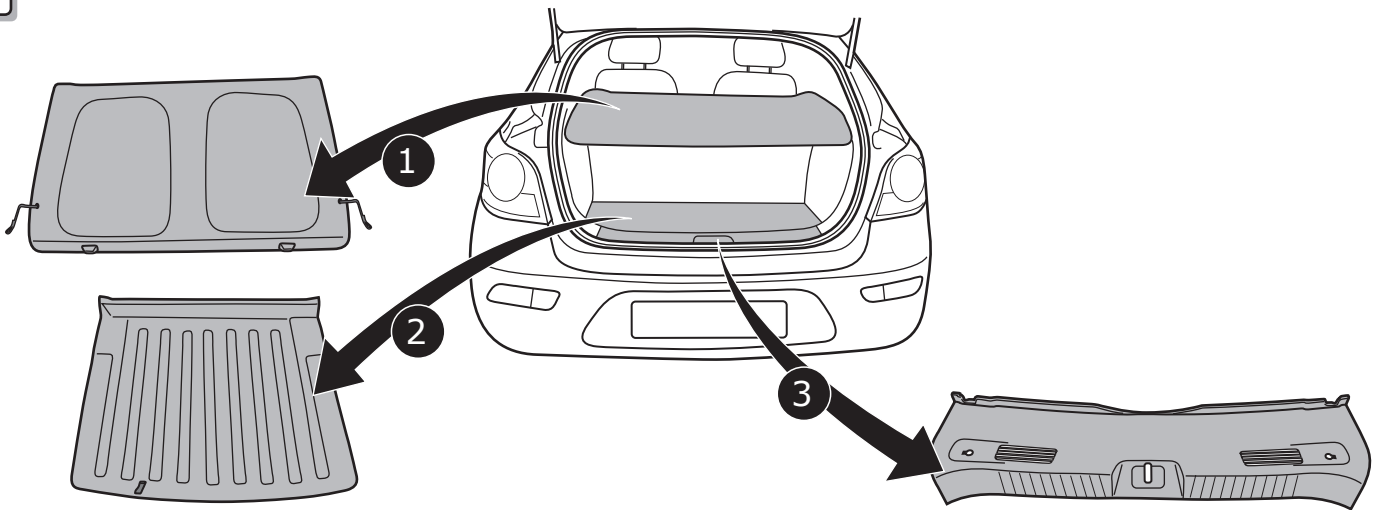

2

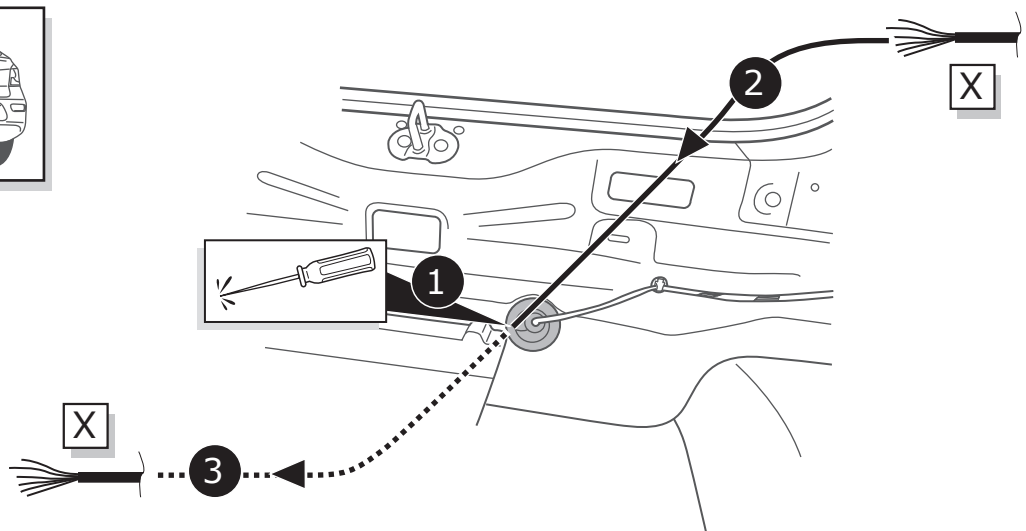
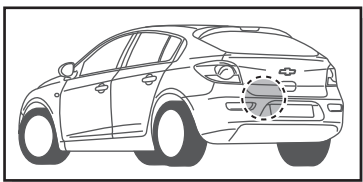

3



Pag. 34

4

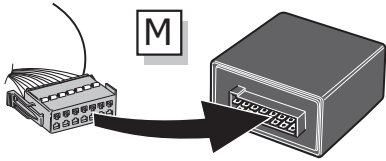

1

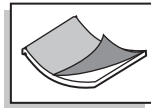

2

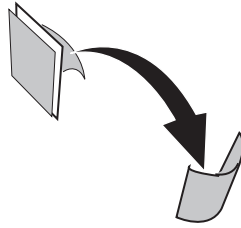

3

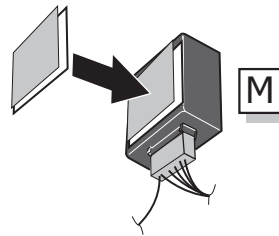

4

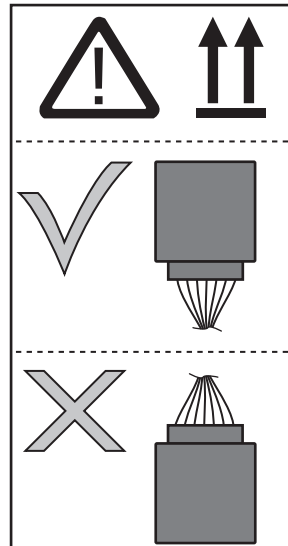
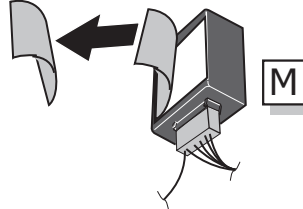

5

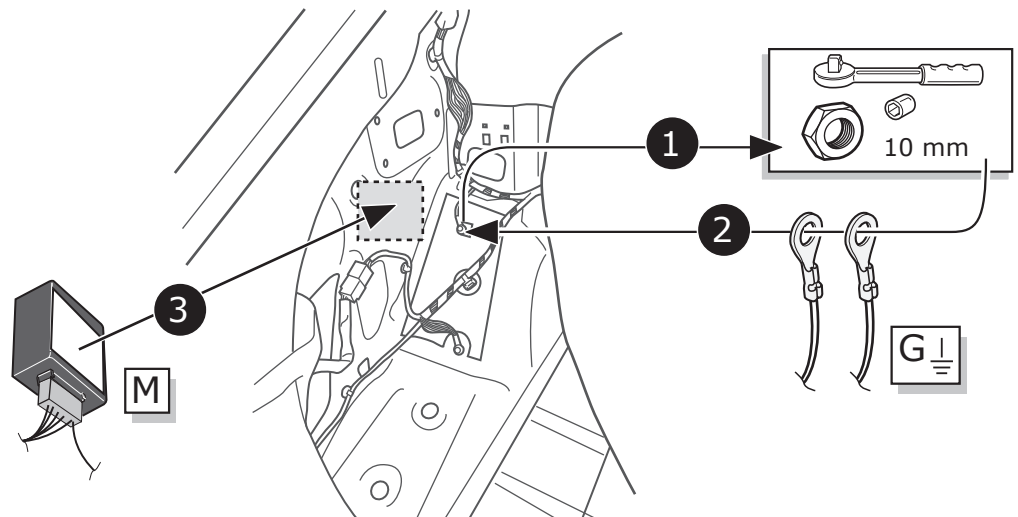
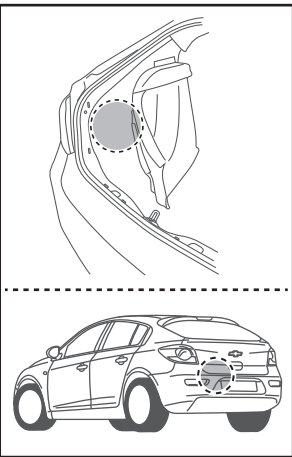

6

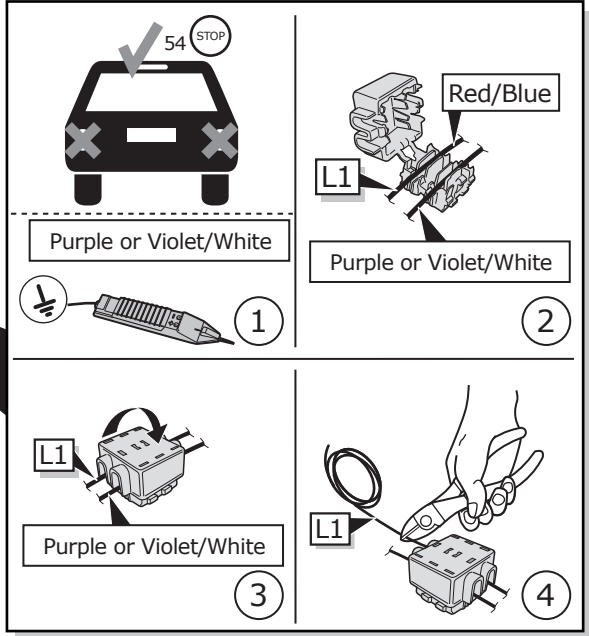
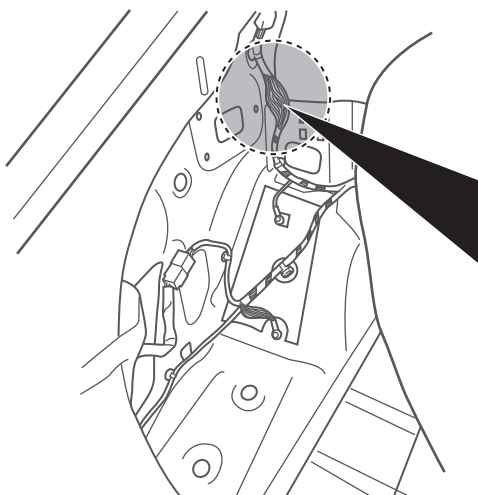
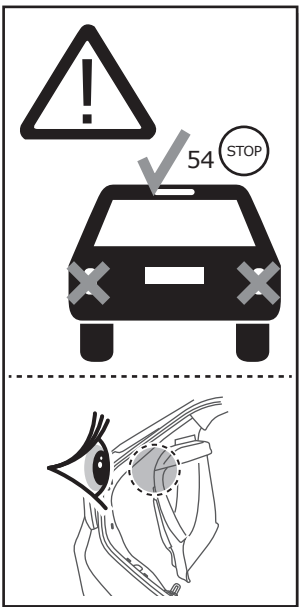

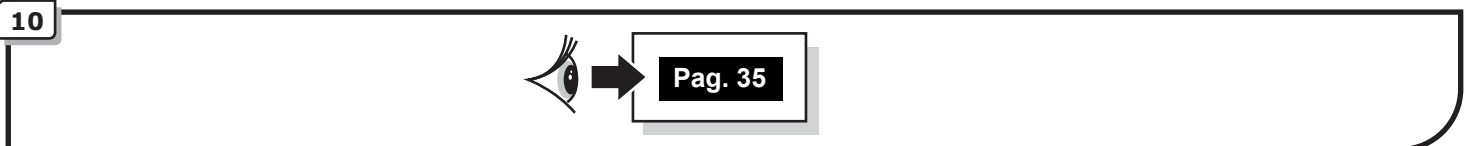
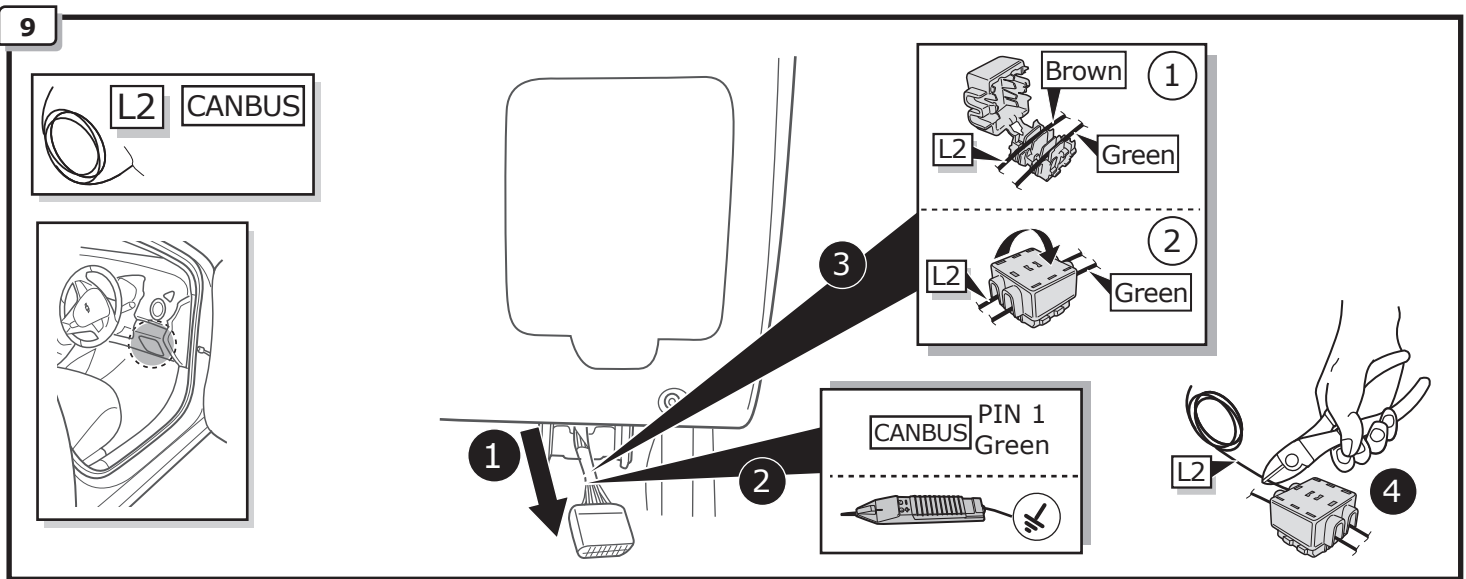
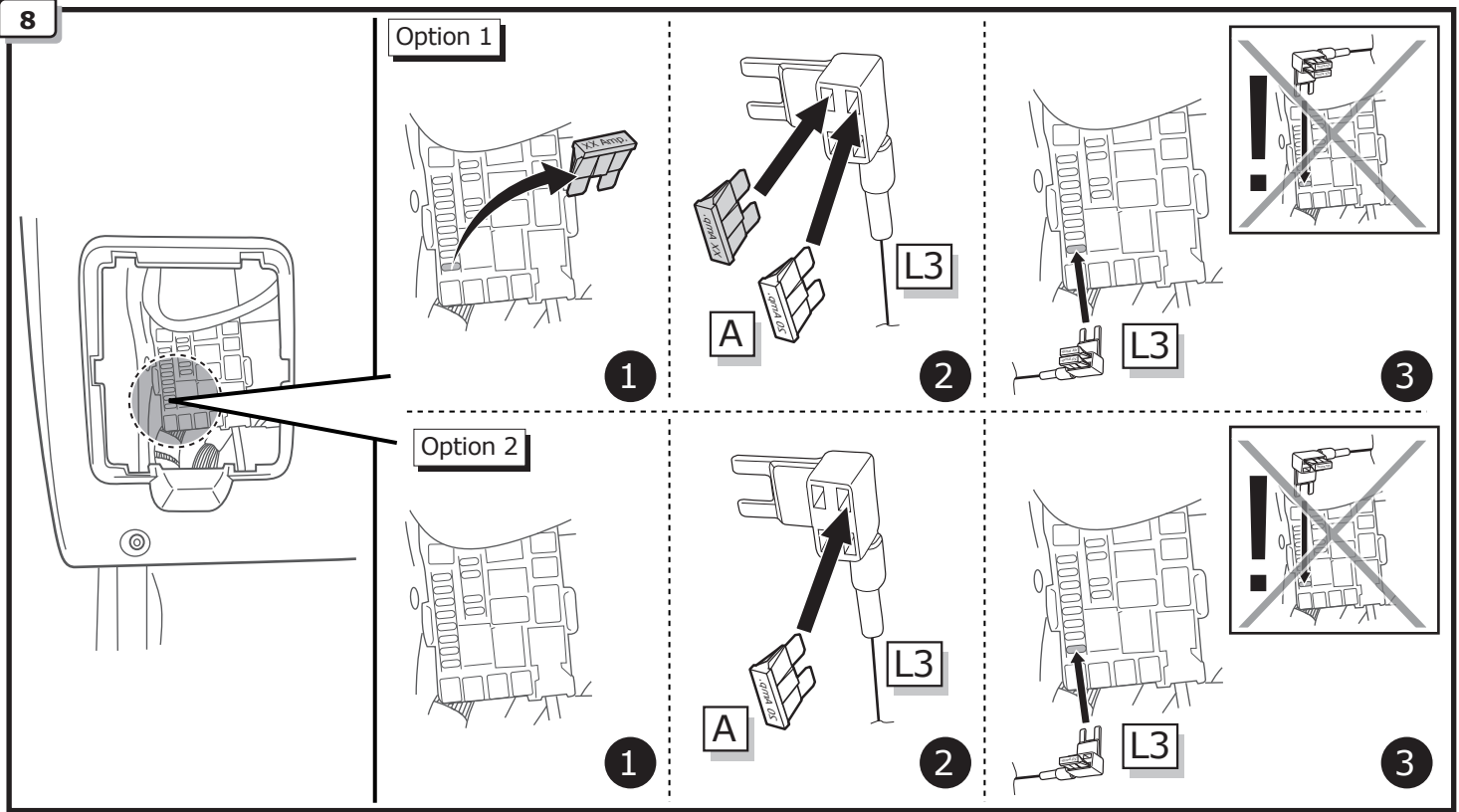
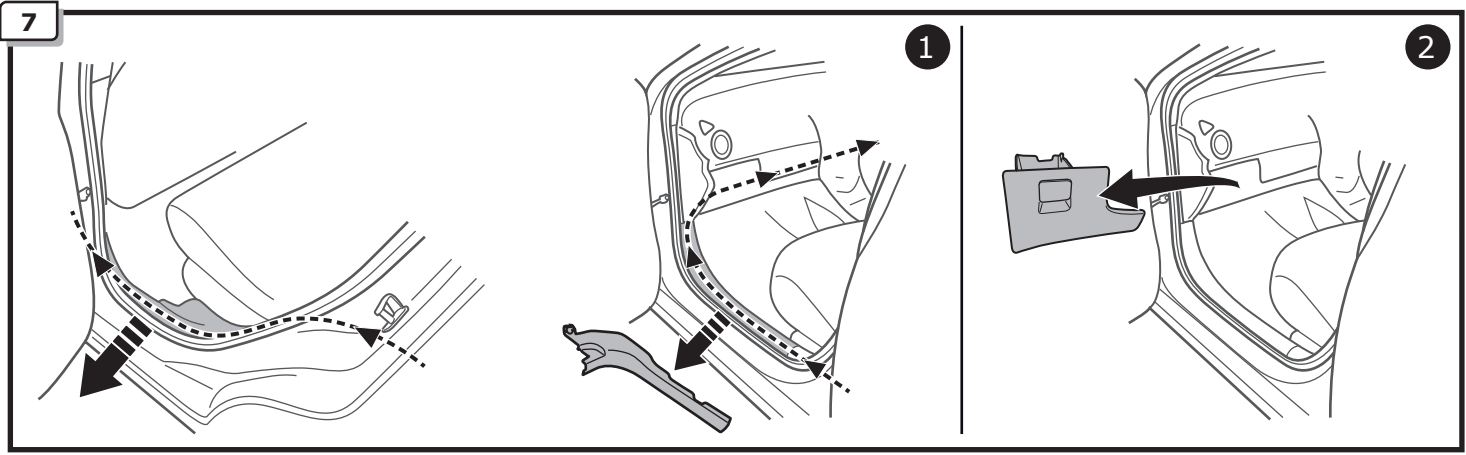

INFO

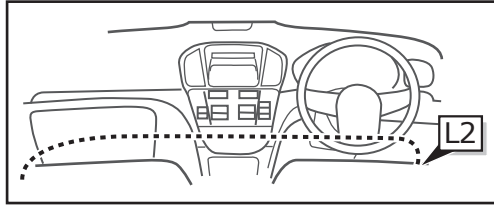
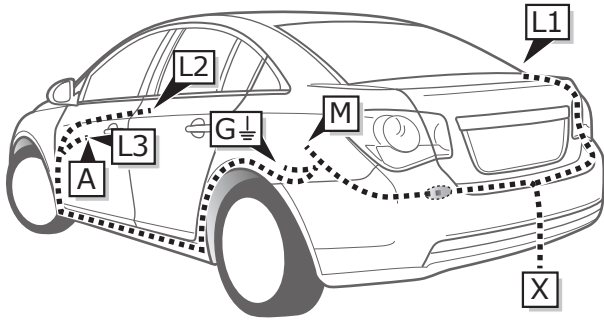

Cruze NB

Pag. 27

-
Pag. 30

1

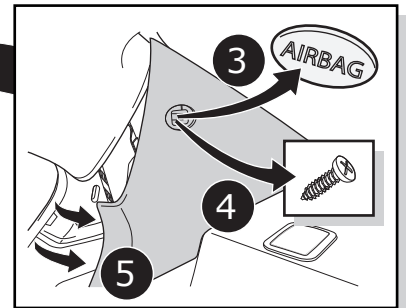
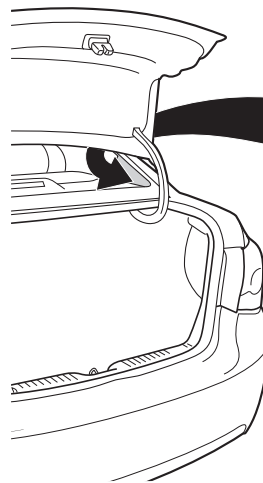
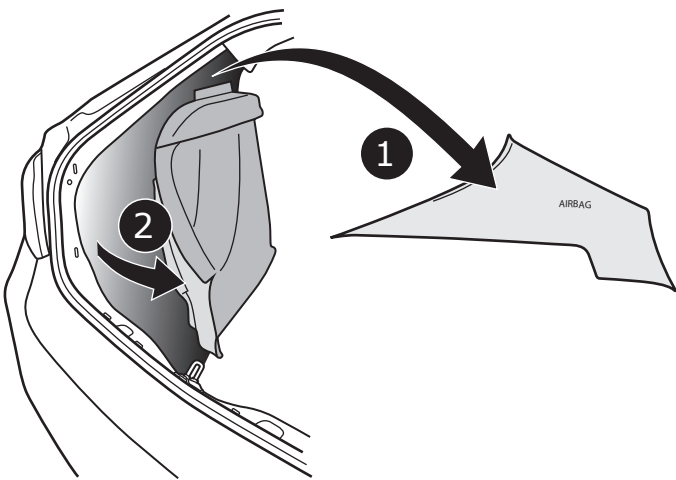

2

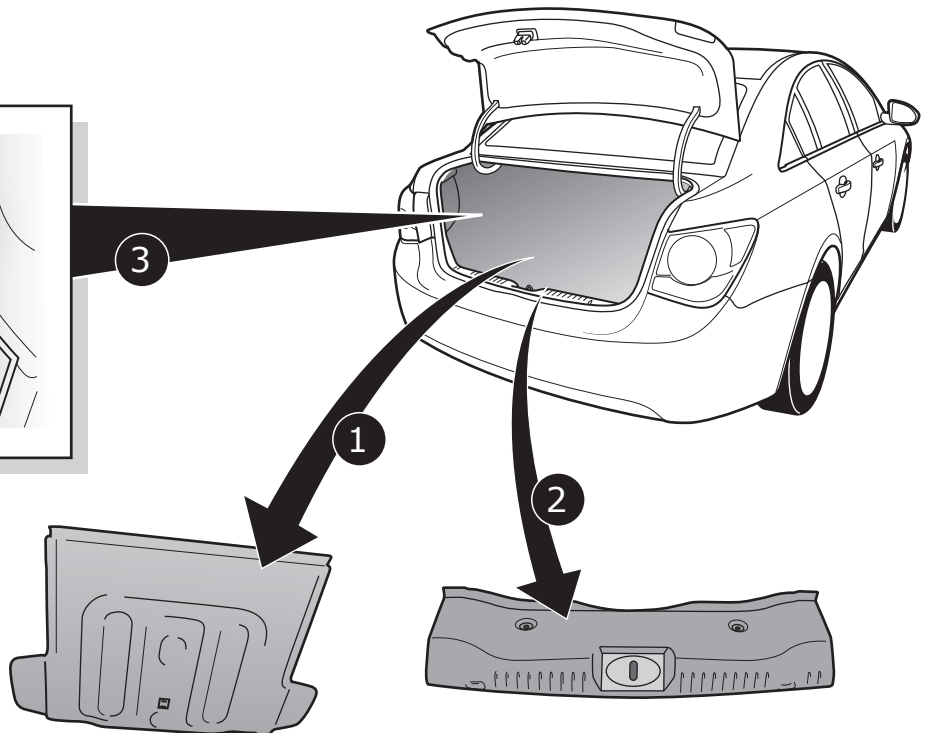
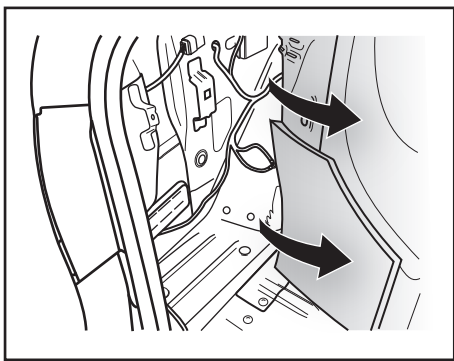

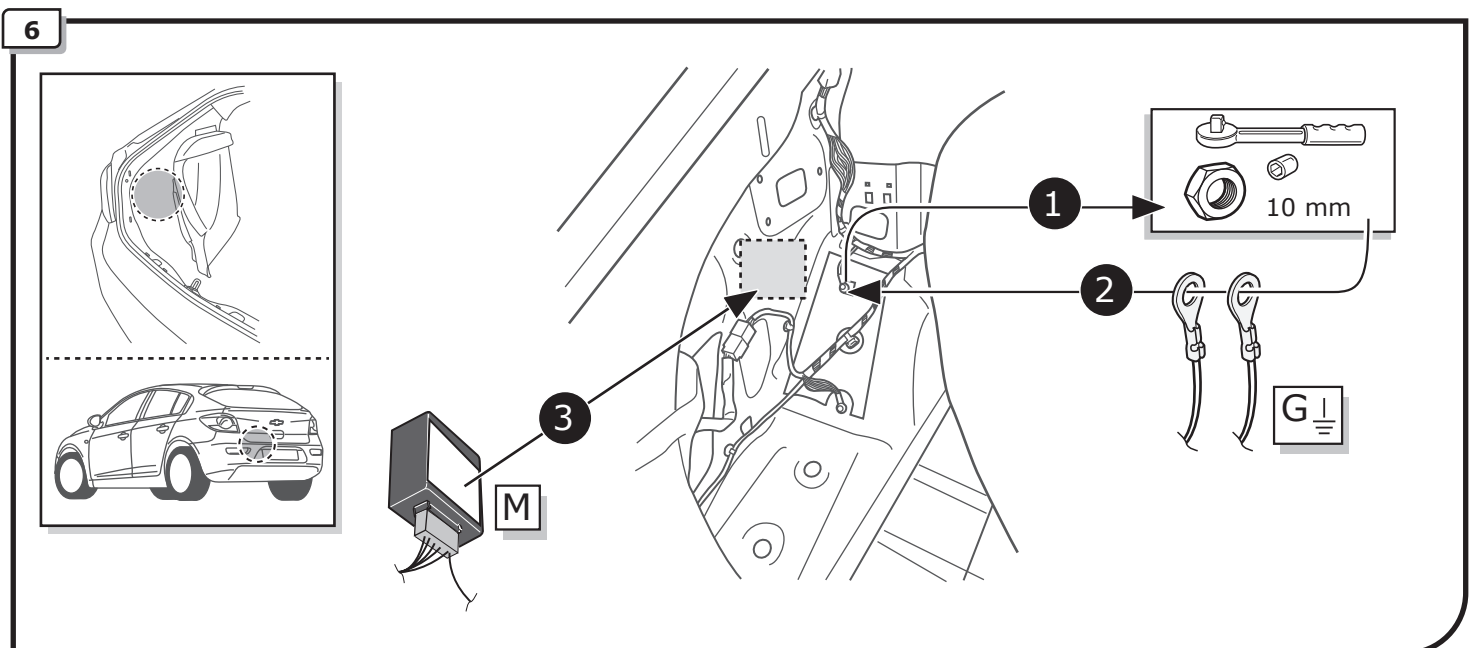
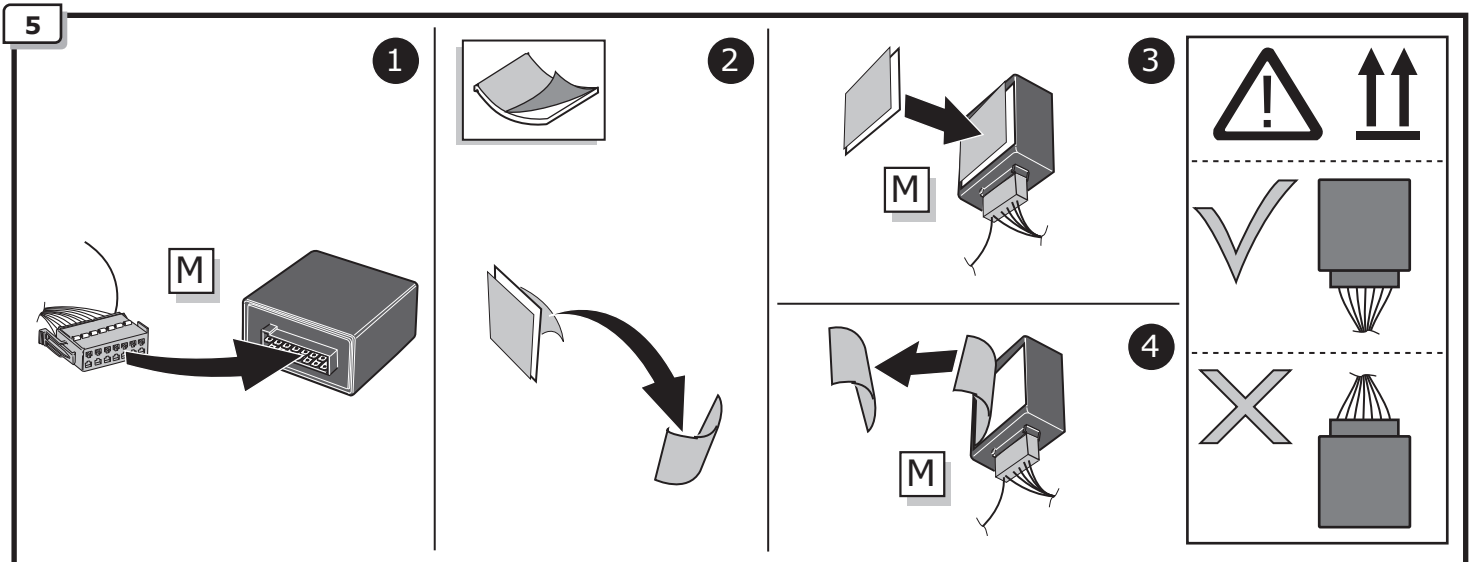
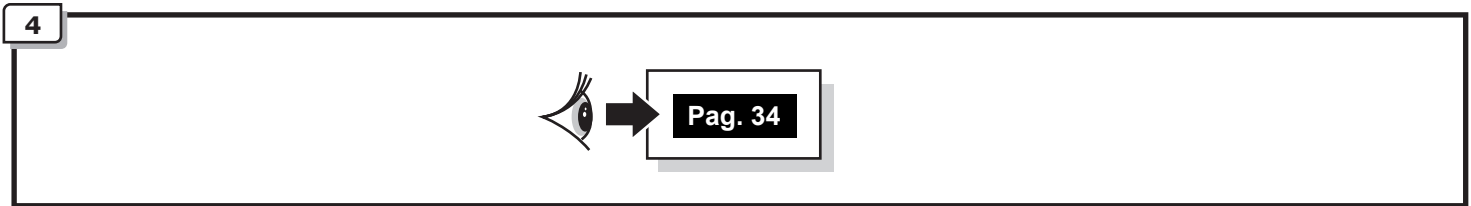
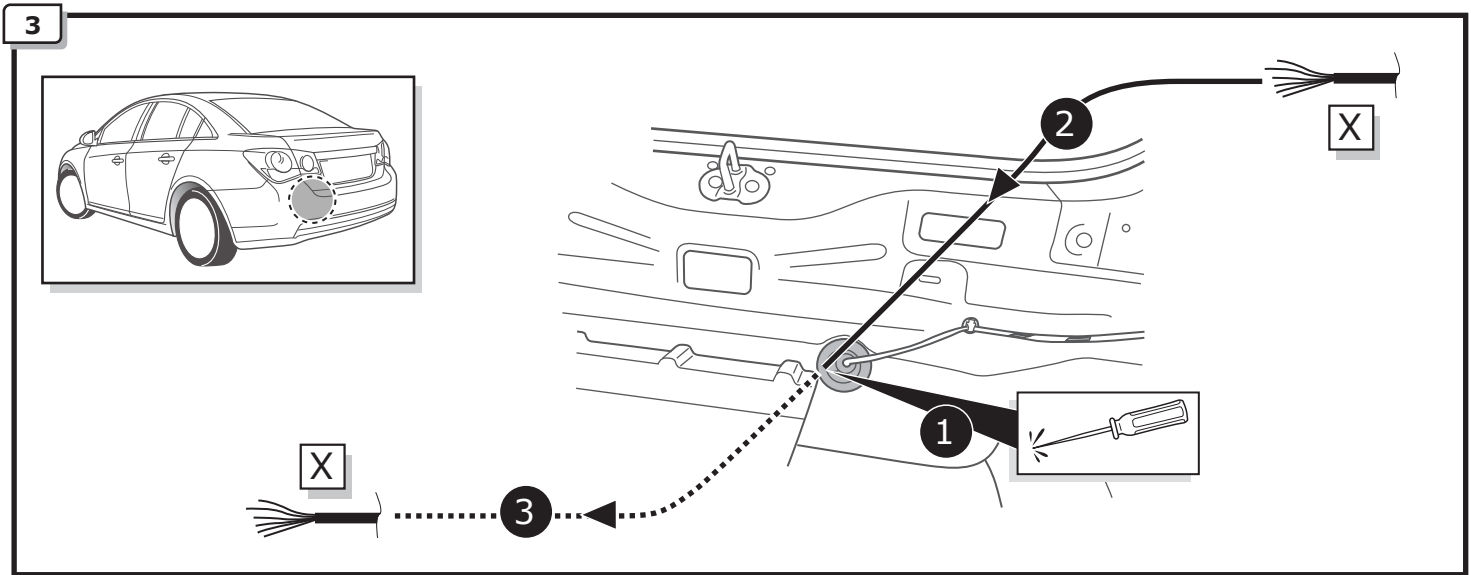

7

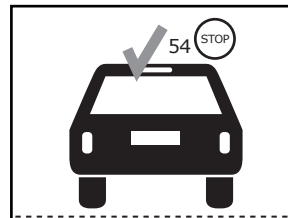
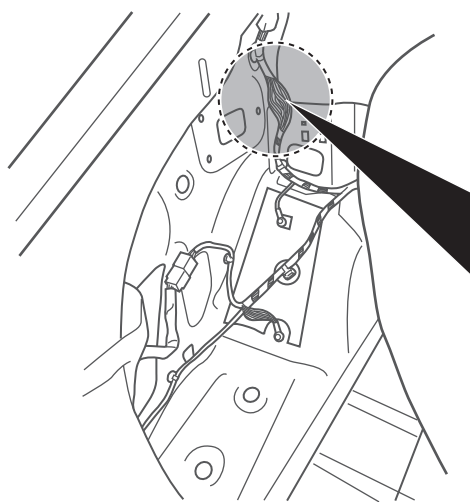
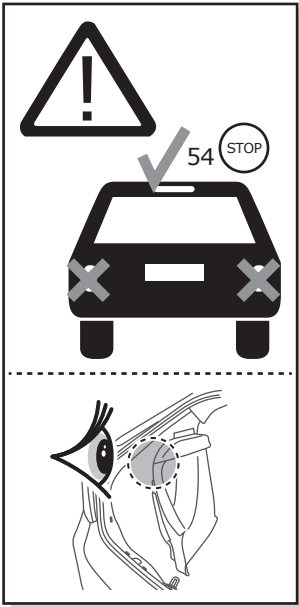

Purple or Violet/White

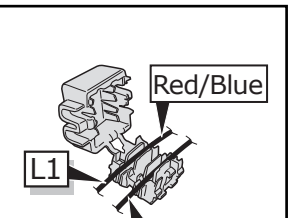

Purple or Violet/White

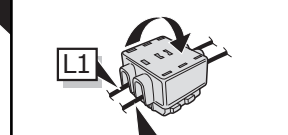

Purple or Violet/White



Purple or Violet/White

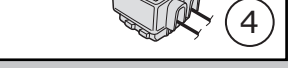

8

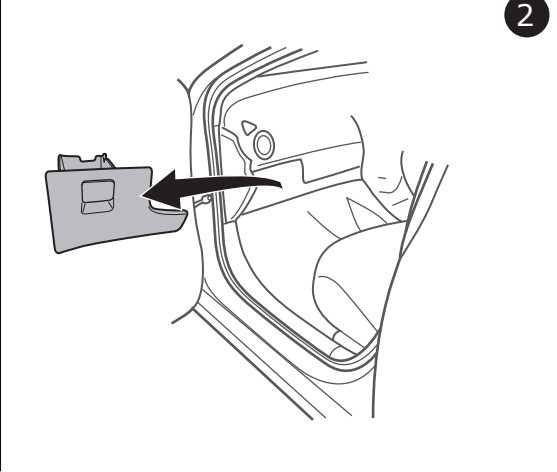
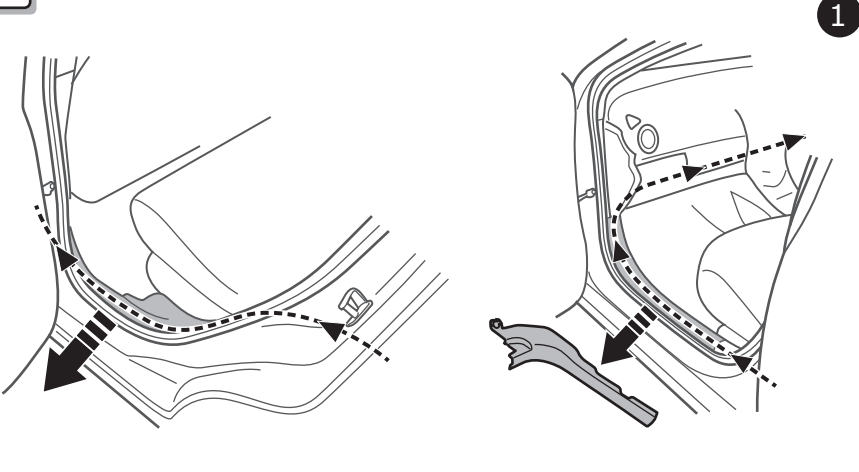

9

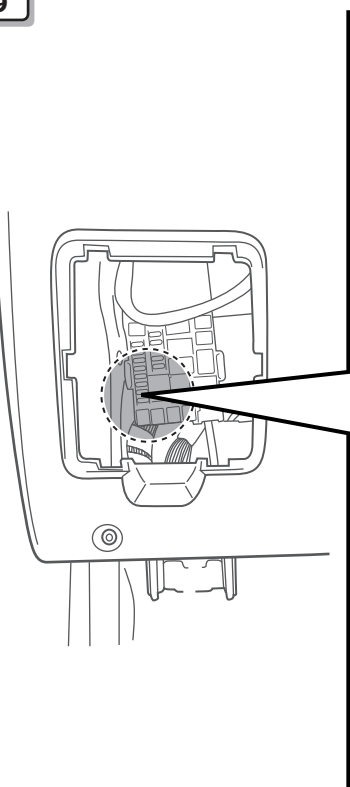

Option 1

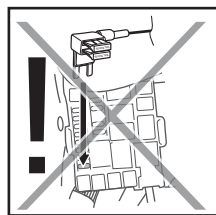
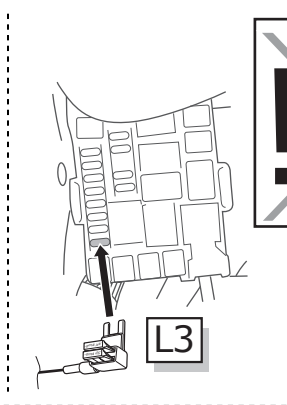
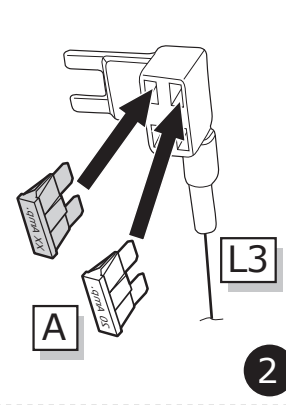
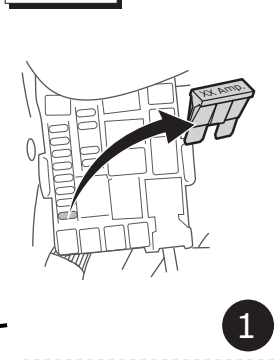

Option 2

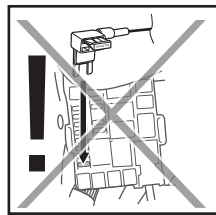
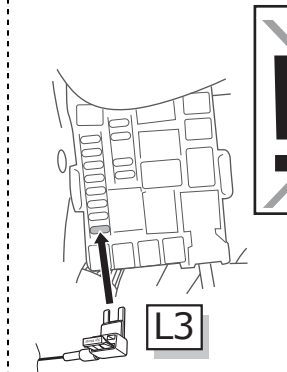
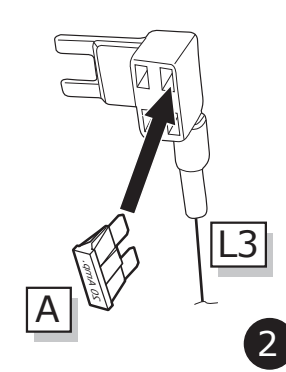
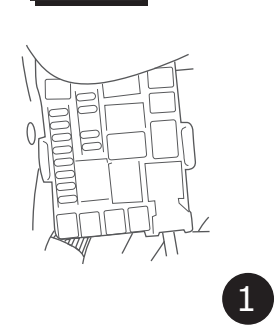

10

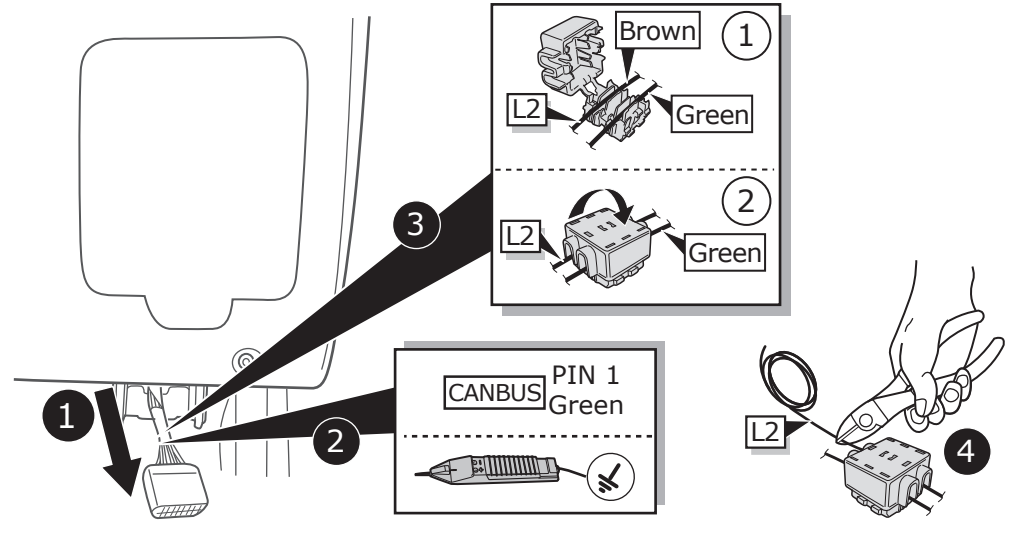
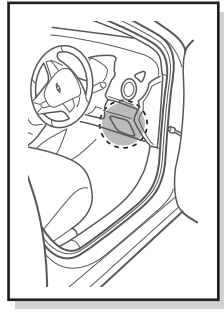
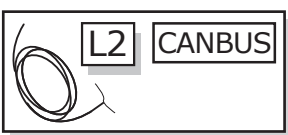

11



INFO

Cruze SW

Pag. 31

Pag. 33

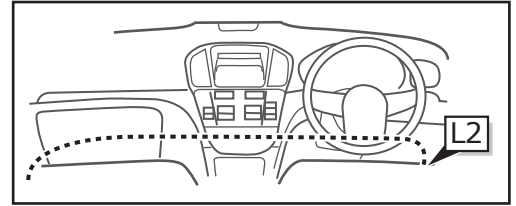
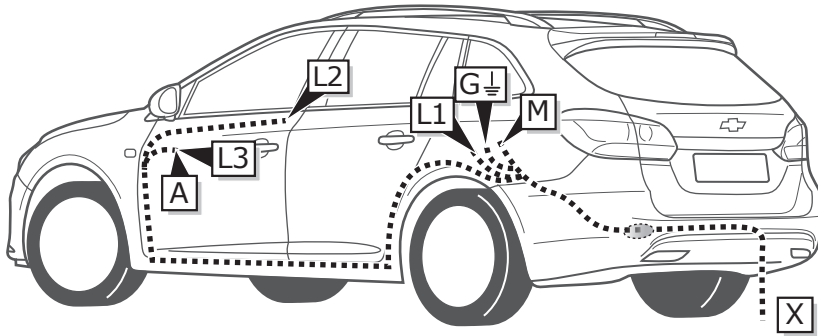

1

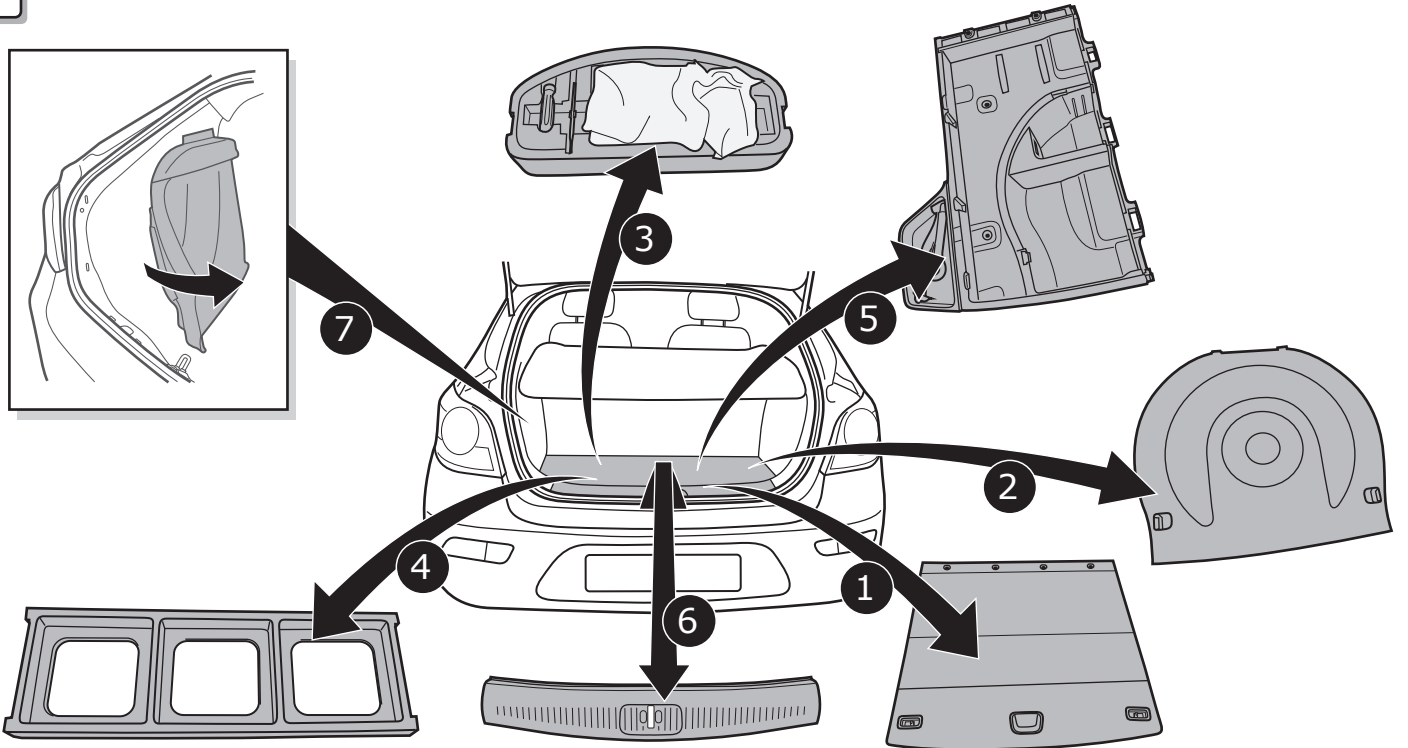

2

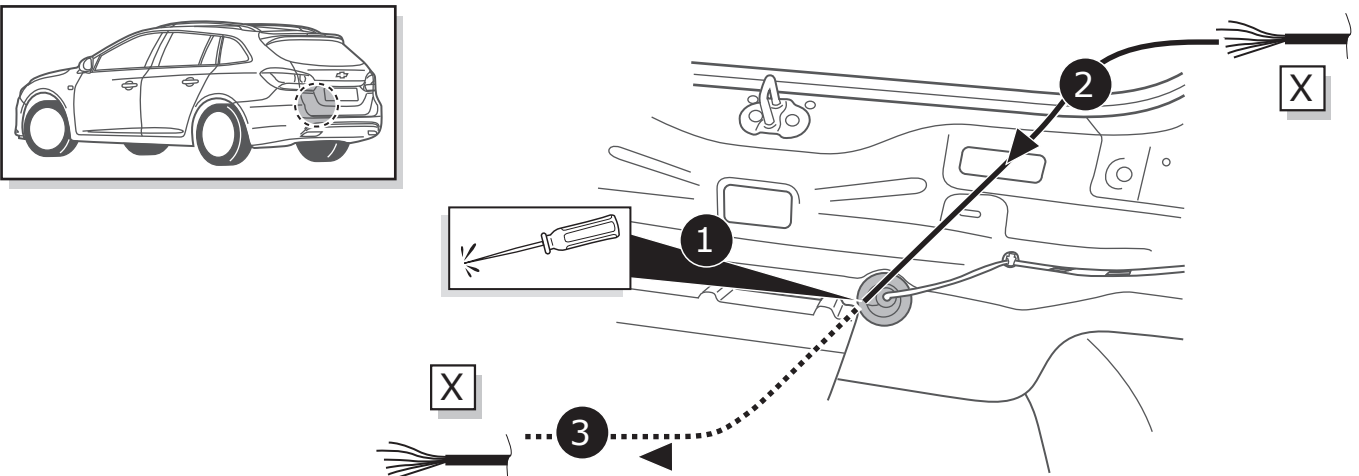

3



Pag. 34

4

1

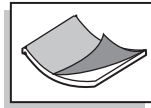
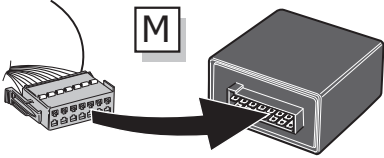

2

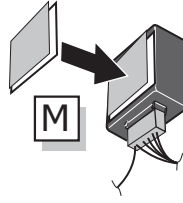
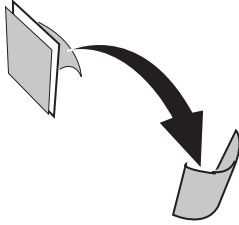

3

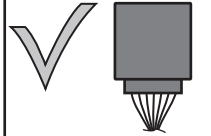

4

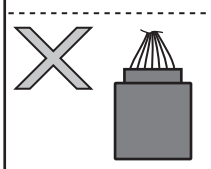

5

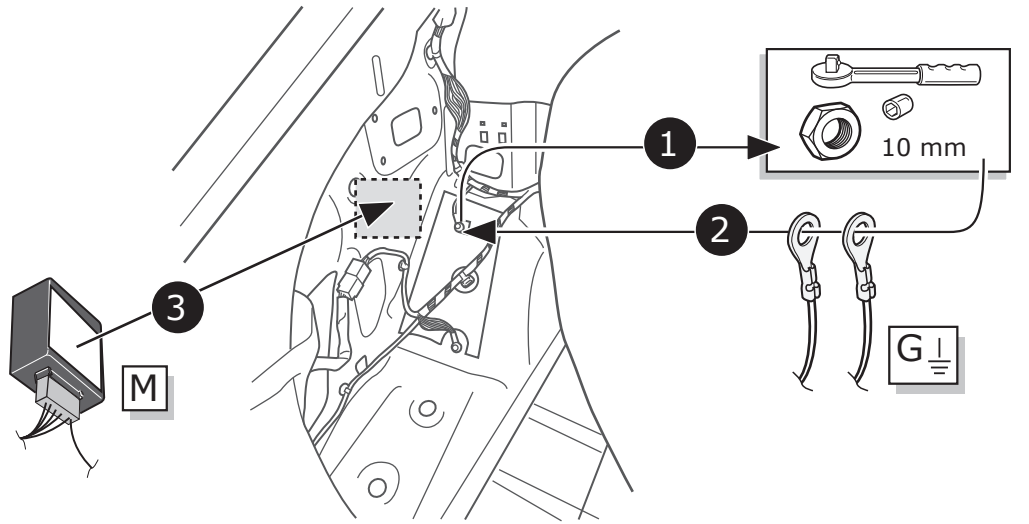
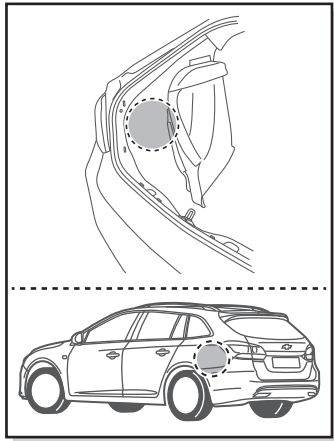

6

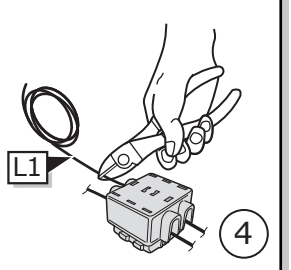
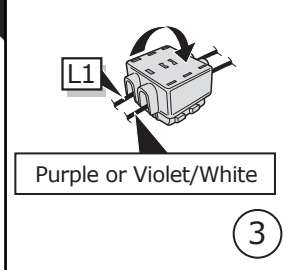
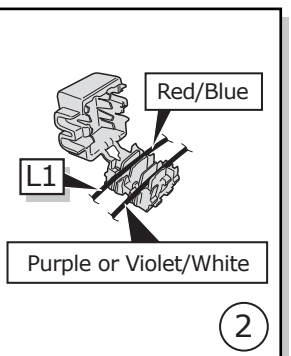
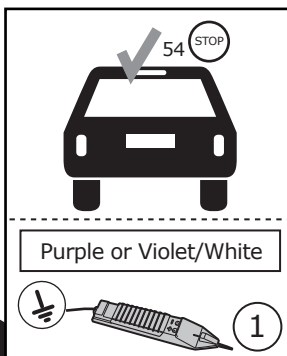
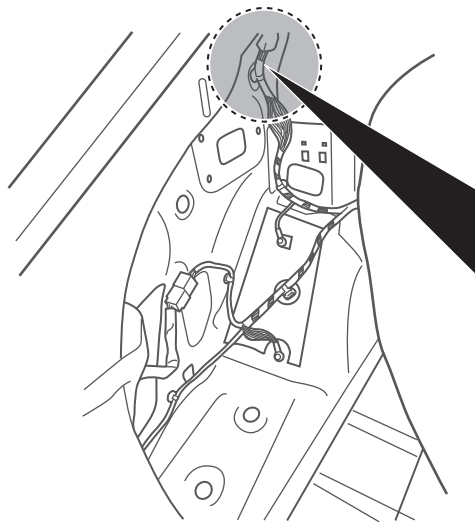
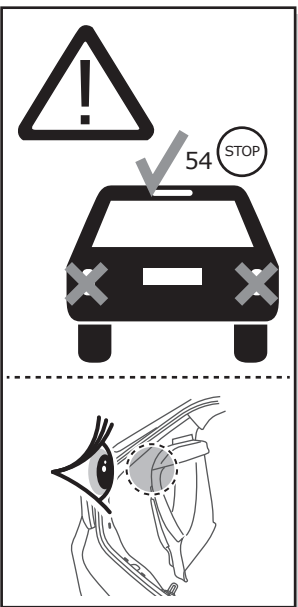

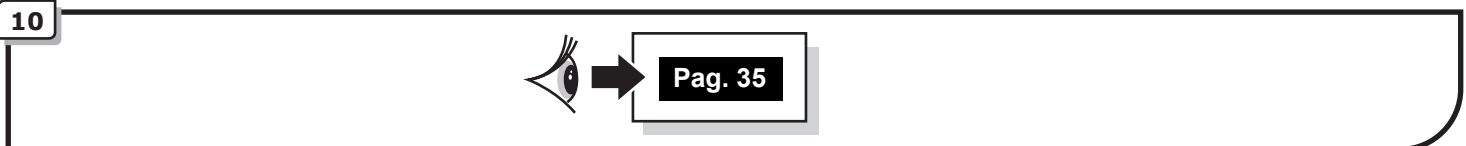
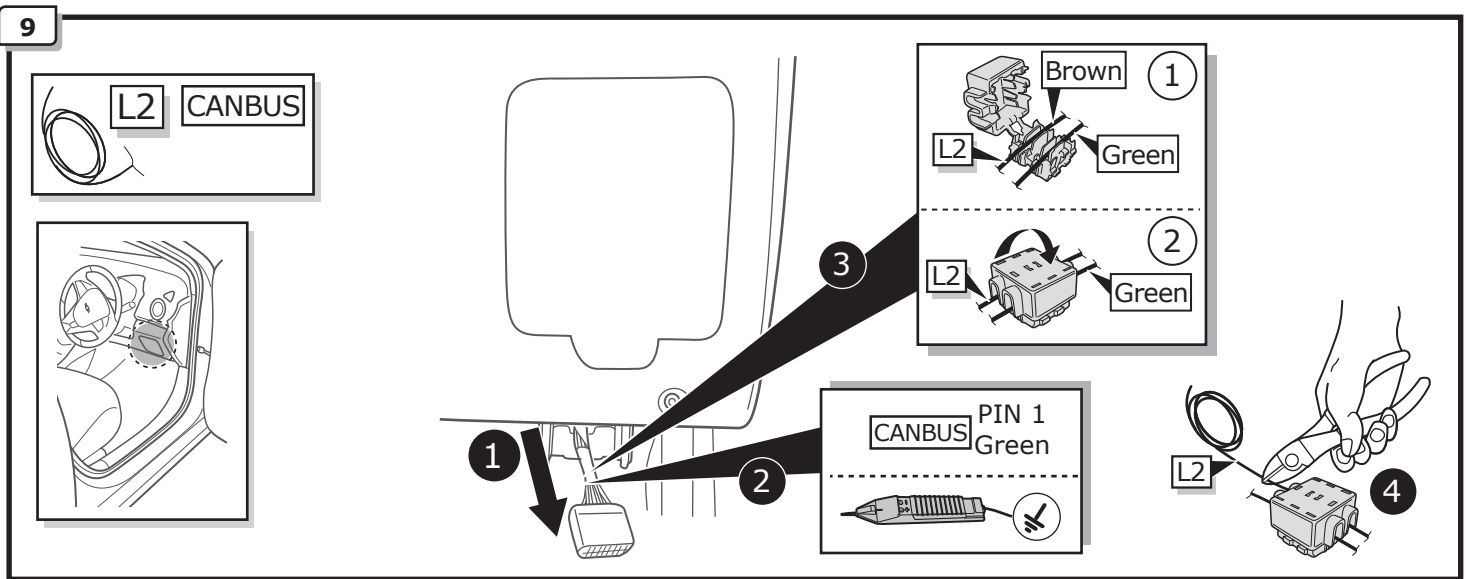
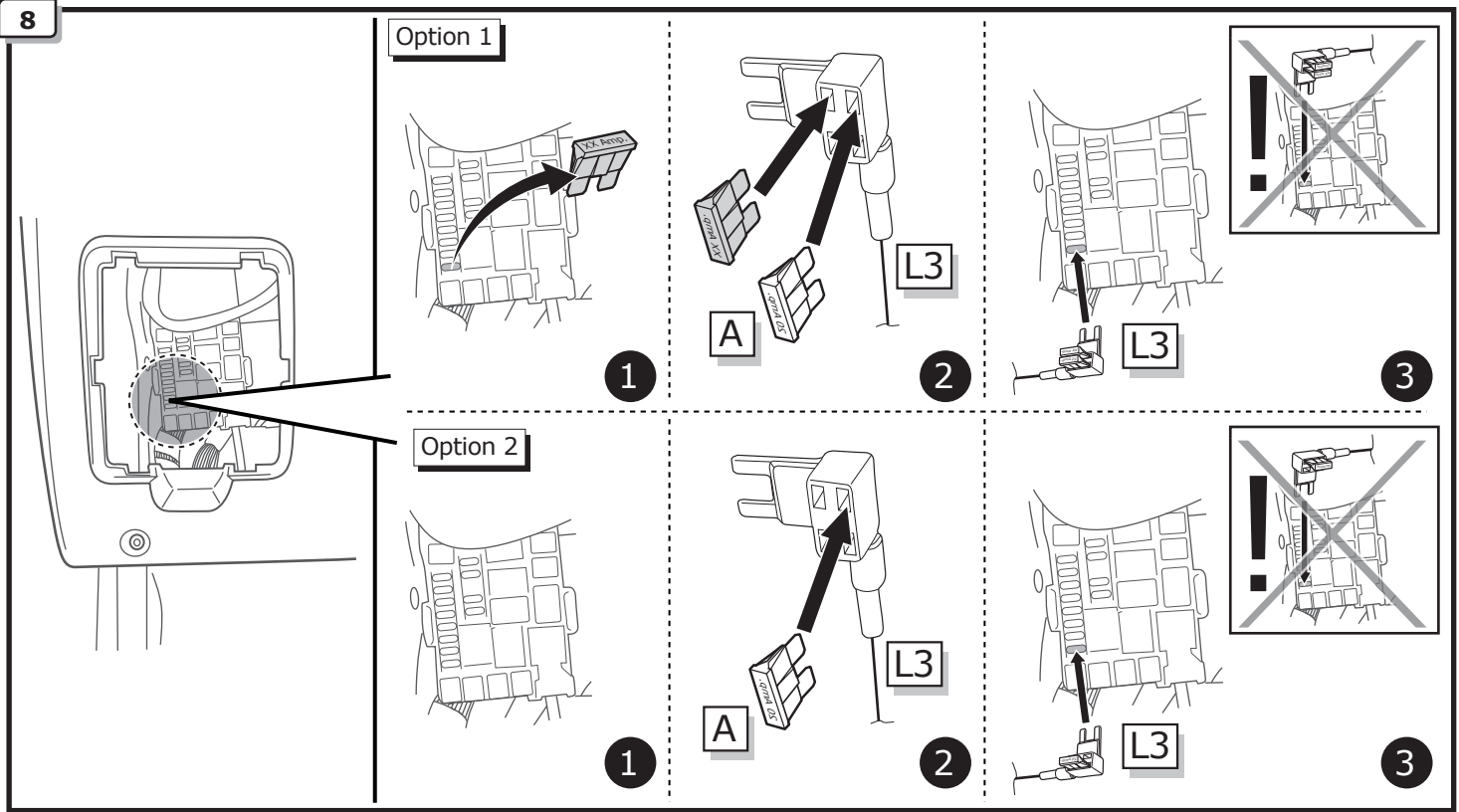
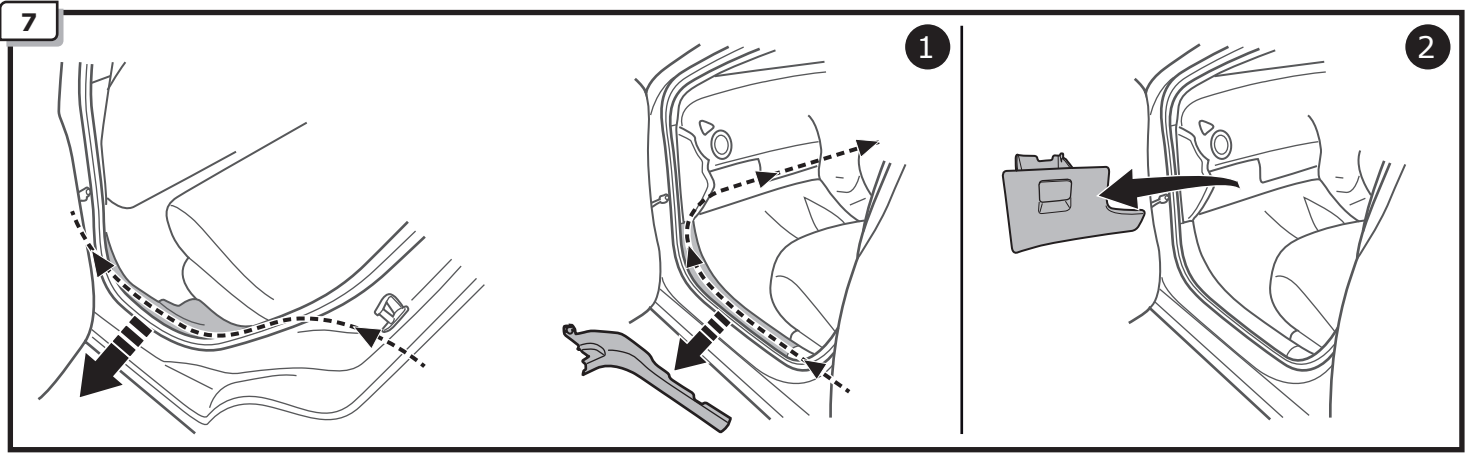

A

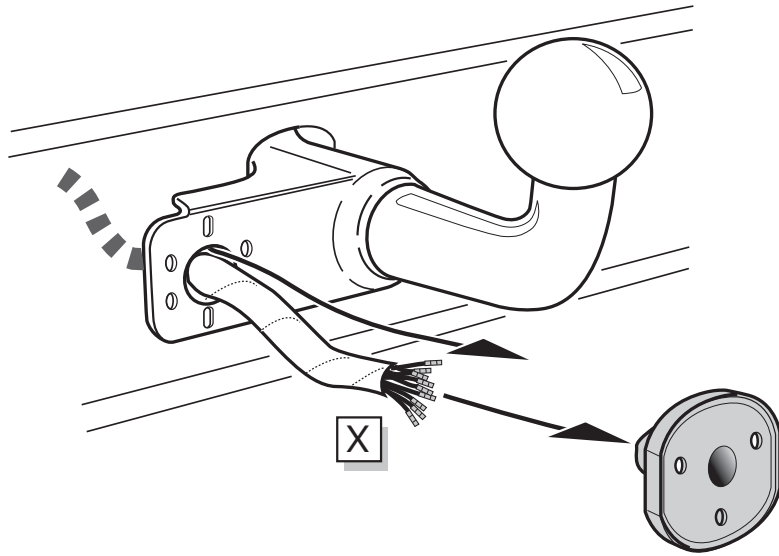

INFO

SOCKET CONNECTION 

Pag. 36

B

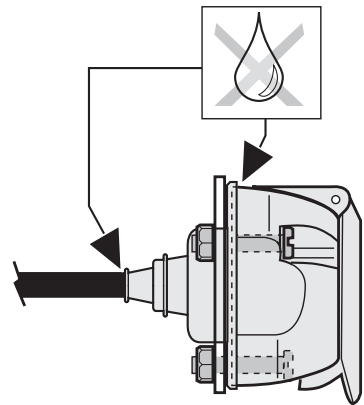
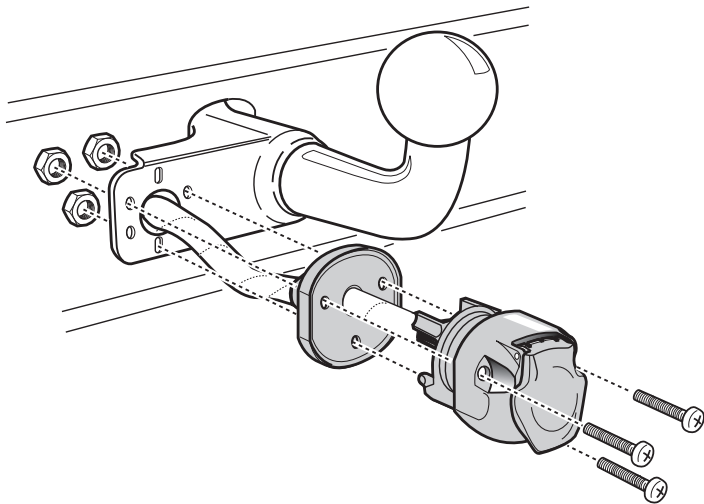

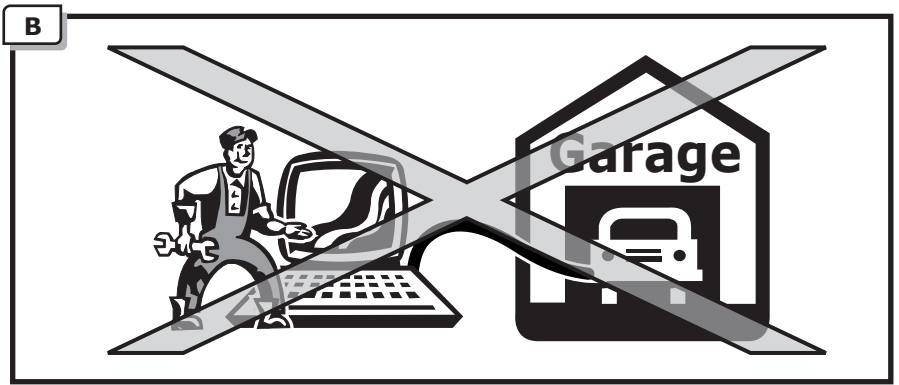
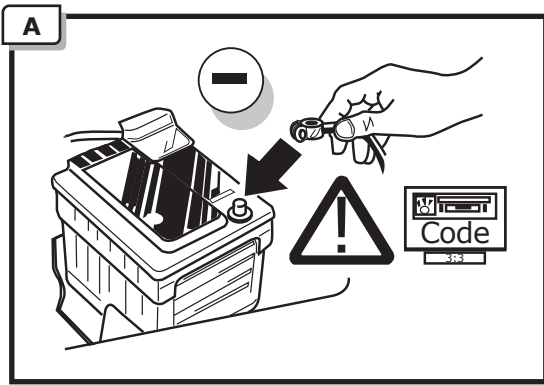

C







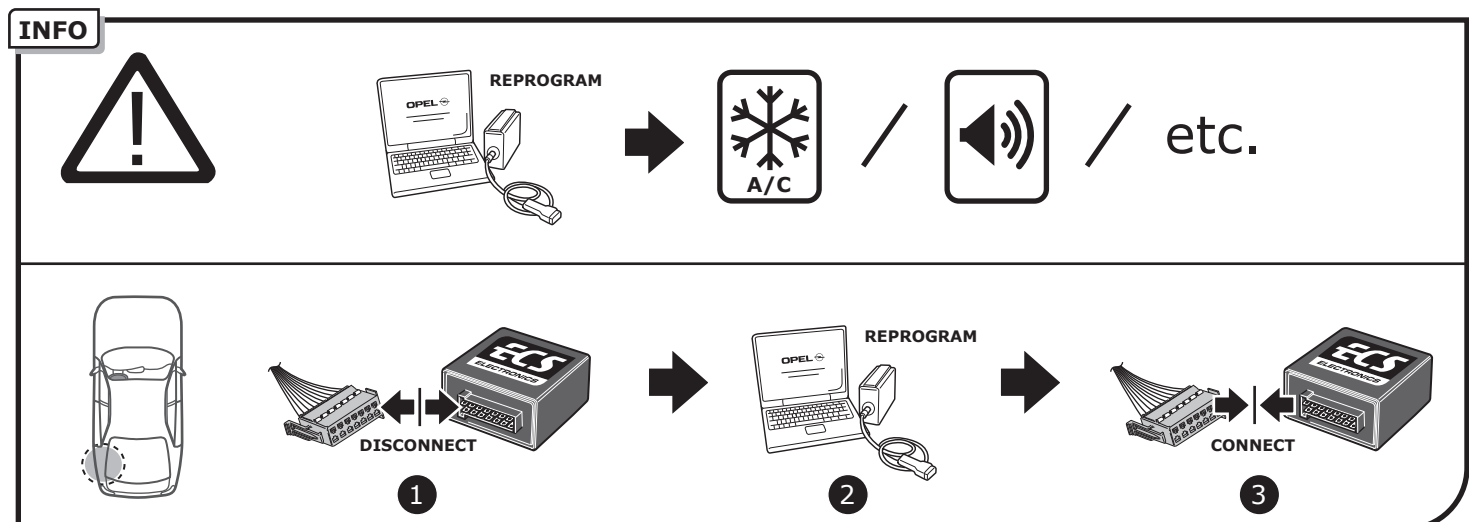
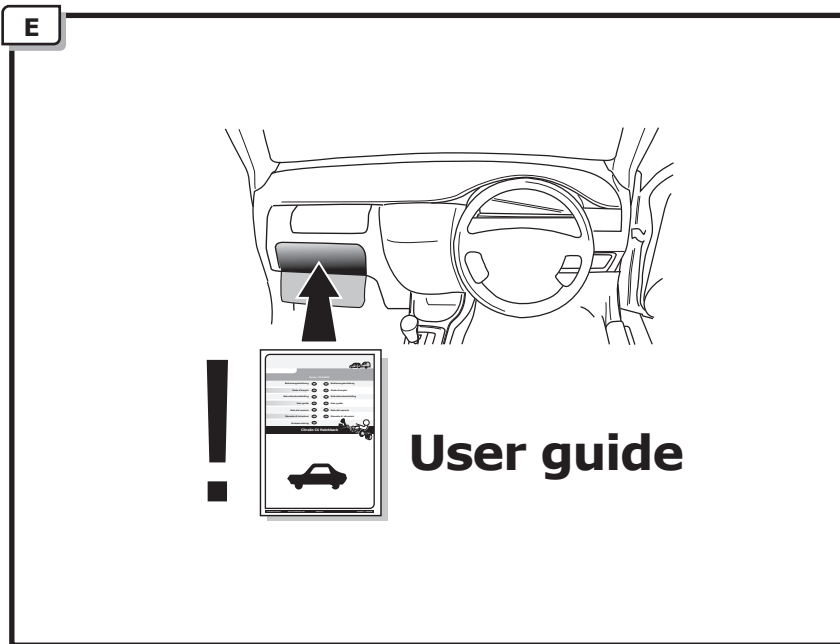





! TEST ALL THE CIRCUITS WITH A TEST DEVICE WITH THE CORRECT POWER LOAD FOR EACH FUNCTION. A TEST DEVICE WITH LED'S CANNOT BE USED FOR THIS PURPOSE.

D

REINSTALL TRIM.



SOCKET CONNECTION

DIN/ISO 11446												—	
	1/L	2	3/31	4/R	5/58-R	6/54	7/58-L	8	9	10	11	12	13
Pmax	21W	21W		21W	42W	3x21W	42W	21W	180W/15Amp	180W/15Amp			
Colour	Yellow	Blue	White	Green	Brown	Red 1,00 mm ²	Black	Black/ Red	Brown/ White	Red 2,50 mm ²	White	-	White